

PARTS AND ACCESSORIES

RADIO * ELECTRICAL * ELECTRONIC
APPLICATIONS

GENERAL RADIO CO.

Cambridge, Mass., U. S. A.

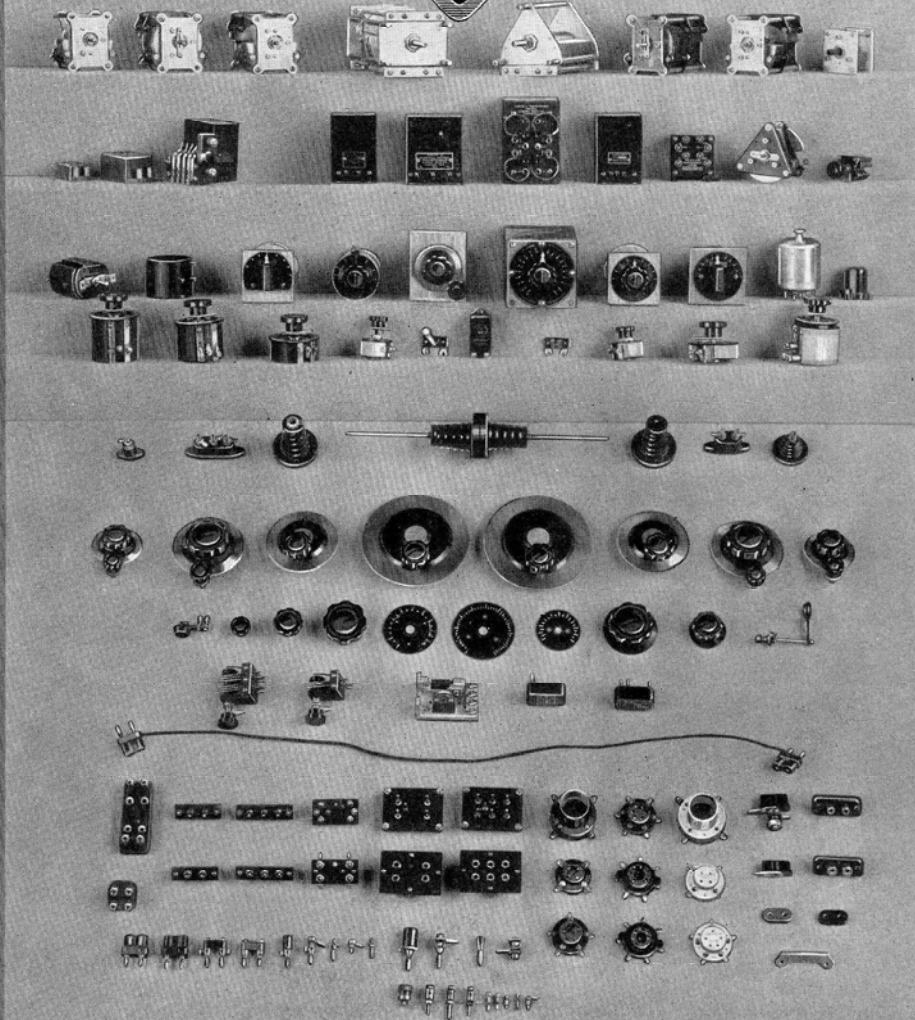

Bulletin
936

January
1935

INTRODUCING A NEW LINE OF PARTS AND ACCESSORIES

DESIGN engineers and experimentalists in the radio, electrical, and allied industrial fields will find in this catalog a variety of unusual accessories that are obtainable nowhere else.

Since 1915 General Radio has manufactured laboratory equipment, frequency-measuring equipment, and components for the Navy, Army, Coast Guard, and other Government services; and for commercial and broadcast

companies, educational institutions, laboratories, and other manufacturers. A reputation has been acquired for building instruments of ruggedness, precision, and dependability.

The parts and accessories which this catalog will introduce to many new customers have all been designed for use in our own equipment. They measure up in every way to the quality standards on which our excellent reputation is based.

SUGGESTIONS FOR ORDERING

ORDER BY TYPE NUMBER

Always order by catalog type number and whenever possible mention ranges or other significant specifications as protection against misunderstanding.

DISCOUNTS

Our prices are made on a direct-to-consumer basis which permits of no discounts except for quantity discounts.

When 10 or more identical items are ordered at the same time for a single shipment, the following quantity discounts are allowed:

10-19.....	5 per cent
20-99.....	10 per cent
100 or more.....	Special discounts quoted on request.

SHIPPING INSTRUCTIONS

All prices are F.O.B. Cambridge, Massachusetts, but when cash accompanies the order, we pay transportation charges to any point in Canada and the continental United States (except Alaska).

Unless specific instructions accompany the order we shall use our judgment as to method of shipment.

PRICE CHANGES

All prices are subject to change without notice. Formal quotations remain open for 30 days.

TAXES

Prices are subject to revision as to any sales or excise taxes, either Federal or local, which may hereafter be imposed.

SHIPMENTS TO GENERAL RADIO

Please return no apparatus for any reason before first asking our Service Department for RETURNED APPARATUS tags.

TELEGRAPH AND CABLE ORDERS

We have direct telegraph printer connections with Postal and Western Union for the prompt handling of telegraph, cable, and radio messages.

Foreign customers will find it convenient to use Bentley's code and the code words accompanying each catalog description. Our cable address is GENRADCO BOSTON.

WE PREPAY SHIPPING CHARGES TO ALL PARTS OF CANADA AND THE CONTINENTAL UNITED STATES (EXCEPT ALASKA) WHEN CASH ACCOMPANIES THE ORDER

BULLETIN 936 — PARTS AND ACCESSORIES

TYPE 500 RESISTOR

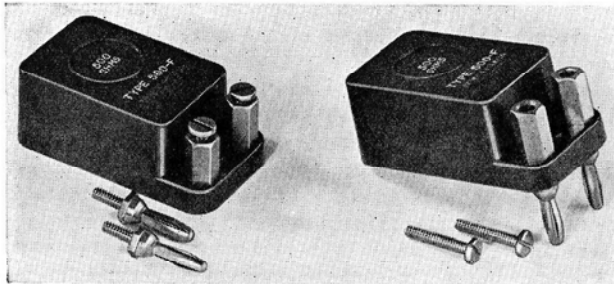

Both screw-type and plug-jack terminals are supplied with TYPE 500 Resistors

This is a moulded bakelite case containing a precision-type resistance card, the equal in quality of the ones used in TYPE 510 Decade-Resistance Units and in General Radio decade-resistance boxes. It is suitable for use in either experimental or permanently assembled equipment requiring a single accu-

rately adjusted resistor, since it has both screw-type and plug-type terminals. Units may be stacked one above the other, the top of the terminal stud acting as a jack for the plug of the unit above it.

TYPE 500 Resistors are particularly recommended for use as resistance standards in plug-in type impedance bridges. They are also useful in test equipment (*e.g.* as terminating impedances in transmission line measurements). Their excellent high-frequency characteristics make them useful in receivers and low-power transmitters when stable performance is of primary importance.

Nine values of resistance are normally carried in stock, but others can be built to order. Quotations on request.

SPECIFICATIONS

Accuracy of Adjustment: Each resistor is adjusted to within 0.1% of its stated value at the terminals of the unit, except the 1-ohm unit which is adjusted to within 1/4%.

Maximum Current: All units will dissipate a maximum power of 1 watt, current corresponding to which is given in the price list.

Frequency Characteristic: There is no serious frequency error below 50 kc. At higher frequencies errors result from skin effect and the appearance of reactance in the resistor.*

Temperature Coefficient: 0.002% per degree C. except on 10,000-ohm cards where it is 0.013% per degree C. at room temperature.

Type of Winding: Ayrton-Perry when resistance is less than 1000 ohms; 1000 ohms and over, unifilar winding on mica cards.

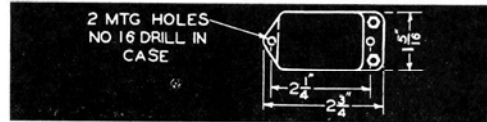

Mounting: Each resistor is sealed in a case of brown moulded bakelite with an impregnating wax that protects the unit from moisture. Two mounting holes are provided (see drawing).

Terminals: Both terminal screws and plugs are supplied, and either can be used. Each terminal stud is recessed as a jack to accommodate a plug.

Dimensions: See accompanying drawing. Over-all height, exclusive of plugs, 1 inch.

Net Weight: 2 ounces.

Type	Resistance	Maximum Current	Code Word	Price
500-A	1 Ω	1.0 a	RESISTBIRD	\$2.00
500-B	10 Ω	310 ma	RESISTDESK	2.00
500-C	50 Ω	140 ma	RESISTFORD	2.00
500-D	100 Ω	100 ma	RESISTFROG	2.00
500-E	200 Ω	70 ma	RESISTGIRL	2.00
500-F	500 Ω	45 ma	RESISTGOAT	2.00
500-G	600 Ω	40 ma	RESISTGOOD	2.00
500-H	1000 Ω	30 ma	RESISTHYMN	2.00
500-J	10,000 Ω	10 ma	RESISTMILK	2.00

*Detailed information on request.

TYPE 510 DECADE RESISTANCE UNIT

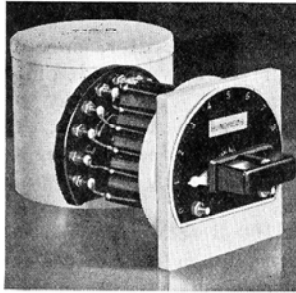

One or more precision decade resistors are frequently required for integral assembly into apparatus operating at low, voice, carrier, or radio frequencies, and in which it is not convenient to incorporate a complete TYPE 602 Decade Resistance Box. The individual units described herewith are available for such use, and, when permanently installed, give the same convenience of a variable, shielded

standard without the unavoidable lead and wiring inductance and consequent errors at high frequencies of the external decade-box construction.

Each resistor is carefully adjusted and aged, the construction being such that there is no serious error at frequencies as high as 50 kc.* Quadruple-leaf switches running over large contacts insure a low and constant contact resistance. Operation is equally satisfactory in d-c circuits.

Each decade is enclosed in an aluminum shield, and a knob and an etched-metal dial plate are supplied. The unit is also available, complete as illustrated with shield, shield cover, blank dial plate, and switch stops, but without resistors, as the TYPE 510-P1 Switch.

SPECIFICATIONS

Accuracy of Adjustment: All resistors are adjusted to within 0.1% of the stated value between card terminals, except the 1-ohm and 0.1-ohm cards, which are adjusted to within 0.25% and 1%, respectively. Where necessary, add 0.002 ohm for each decade to allow for contact resistance.

Maximum Current: Maximum allowable temperature rise is 40°C. The currents for a 20°C. rise are approximately 0.6 of those for a 40°C. rise, values of current for each of the above conditions for each of the decades are shown in the table at the foot of the page.

Frequency Characteristics: There is no serious frequency error below 50 kc. At higher frequencies errors result from skin effect and the appearance of reactance in the resistors.*

Temperature Coefficient: 0.002% per degree C. except on 10,000-ohm cards where it is 0.013% per degree C. at room temperature.

Type of Winding: Bifilar type on 0.1-ohm,

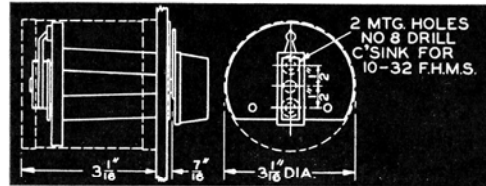

Ayrton-Perry on 1-, 10-, and 100-ohm, and the unifilar mica type on 1000- and 10,000-ohm cards.

Switch: Quadruple-leaf, phosphor-bronze blades, canted to provide a non-cutting, wiping contact, bear on 3/8-inch studs. A cam-type detent is provided. There are 11 contacts.

Mounting: Adaptable to any panel between 1/4 and 3/8 inch. See sketch.

Dimensions: See sketch. Shaft diameter, 3/8 inch.

Net Weight: TYPE 510 units, 11 ounces; TYPE 510-P1, 9 1/2 ounces.

Type	Resistance		Maximum Current		Code Word	Price
	Total	Per Step	20°C. Rise	40°C. Rise		
510-A	1 Ω	0.1 Ω	1 a	1.5 a	ELATE	\$8.50
510-B	10 Ω	1 Ω	600 ma	1 a	ELDER	8.50
510-C	100 Ω	10 Ω	170 ma	250 ma	ELEGY	8.50
510-D	1000 Ω	100 Ω	50 ma	80 ma	ELBOW	8.50
510-E	10,000 Ω	1000 Ω	5 ma	23 ma	ELECT	12.00
510-F	100,000 Ω	10,000 Ω	5 ma	7 ma	ELVAN	14.00
510-P1	Switch				ENVOY	5.00

*Detailed information on request.

TYPE 668 COMPENSATED DECADE RESISTANCE UNIT

Although the inductance of TYPE 510 Decade Resistance Units has been reduced to a very small value, it is still large enough to introduce errors in precise capacitance measurements at radio frequencies and inductance measurements at audio frequencies. It is impossible to build an ideal, inductance-free resistor, and the next best thing is a unit in which the inductance is kept constant.

The TYPE 668 Compensated Decade Resistance Unit is equipped with a double set of switch contacts, by means of which a copper winding is exchanged, step by step, for the resistive turns in order to keep the total inductance independent of the resistance setting. The total inductance of each unit is given in

the price list.*

The method of mounting is identical with that of the TYPE 510 Decade Resistance Unit, except that no aluminum shield is provided. The three types of this unit, when mounted together or combined with TYPES 669-A or -R as a resistance box, are available as the TYPE 670 Compensated Decade Resistor.*

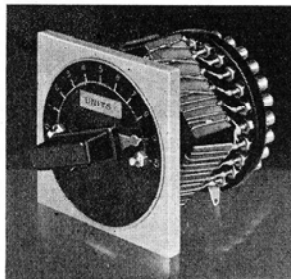

*Detailed information on request.

SPECIFICATIONS

Type of Winding: Same as for TYPE 510 Units.

Switch: A double switch, similar in construction to the single switch used with TYPE 510, is used.

Maximum Current: Maximum allowable temperature rise is 40° C. for which the maximum currents are 1.6 a, 0.5 a, and 0.16 a, for the 0.1-, 1-, and 10-ohm steps, respectively. The currents for a 20° rise are approximately 0.6 of these values.

Accuracy of Adjustment: For 0.1-ohm decade, 1%; for 1-ohm decade, 0.25%; for 10-ohm decades, 0.1%. Where necessary, add the value of "Zero Resistance" given in the price list. Inductance constant to within 0.05 μh.

Frequency Characteristic: Approximately the same as for TYPE 510.

Mounting: A combination dial plate and drilling template are furnished. Interchangeable (except for stops) with TYPE 510, *q.v.*

Dimensions: Diameter, 3 1/8 inches; depth behind panel, 3 inches, over-all; shaft diameter, 3/8 inch.

Net Weight: 10 ounces.

Type	Resistance			Total L	Code Word	Price
	Total	Steps	Zero			
668-A	1 Ω	0.1 Ω	0.005 Ω	0.15 μh	GABLE	\$15.00
668-B	10 Ω	1.0 Ω	0.020 Ω	0.3 μh	GAILY	15.00
668-C	100 Ω	10.0 Ω	0.015 Ω	0.5 μh	GALOP	15.00

TYPE 669 COMPENSATED SLIDE-WIRE RESISTOR

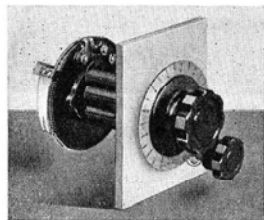

This unit is a slide wire, compensated for inductance, for use where it is desired to secure a closer adjustment of resistance than is possible with a

with a dial individually engraved at 11 points, giving the slide-wire resistance to within 1% for the 1-ohm and 5% for the 0.1-ohm units. Where necessary, add the value of "Zero Resistance" given in the price list. Inductance constant to within 0.005 μh.

Mounting: Interchangeable with TYPE 510, except for the use of dial and slow-motion drive. A dial indicator is supplied.

Dimensions: Diameter, 3 1/2 inches; depth behind panel, 3 inches, over-all.

Net Weight: 8 ounces.

TYPE 668 Compensated Decade Resistance Unit.*

*A description of the constructional details is available on request.

SPECIFICATIONS

Maximum Current: For 1-ohm unit, 1.6 a; for 0.1-ohm unit, 5 a.

Accuracy of Calibration: Each unit is fitted

Type	Resistance		Total L	Code Word*	Price
	Max.	Zero			
669-A	1 Ω	0.045 Ω	0.15 μh	GAMIN	\$25.00
669-R	0.1 Ω	0.020 Ω	0.15 μh	GAZEL	25.00

TYPE 653 VOLUME CONTROL

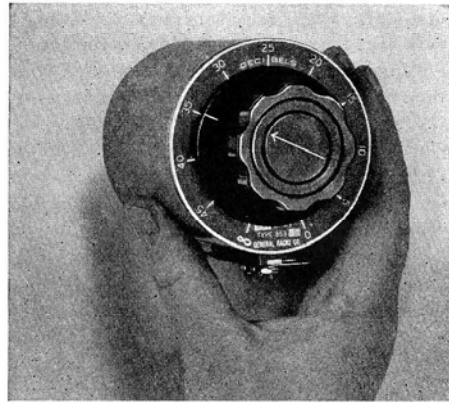
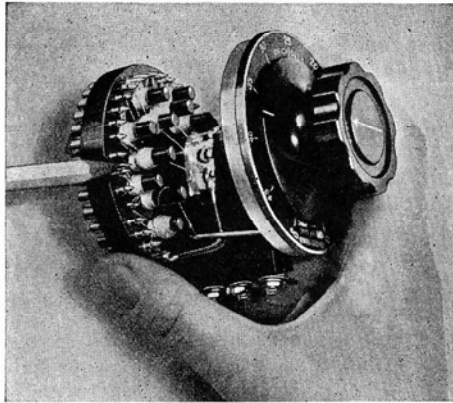

This volume control is an ideal mixer-circuit unit where the noise-level restrictions are especially severe. Many are in use in broadcasting and recording studios where low cost and trouble-free operation make them the ideal solution to the speech-input control problem.

Of particular importance is the extremely low noise level, even when the unit is used in a microphone mixer circuit without pre-amplification as is usually the case in dynamic- and velocity-type installations. There is only

one sliding contact (reducing by half the inherent contact noise over that in double-contact controls), and this one contact has been made practically noiseless through the correct choice of materials. The impedance remains practically constant in both directions throughout the attenuation range.

Another feature, found only in a volume control of this type, is the ability to "fade out" completely without disturbing associated channels.

SPECIFICATIONS

Attenuation Range: 0 db to complete cut-off. Attenuation is linear with dial setting and adjustable from 0 to 45 db in steps of about $\frac{3}{4}$ db. (Attenuation between contacts is 1.5 db, but the switch bridges two contacts in passing from one to the other.) Above 45 db, the rate of attenuation increases rapidly to "infinity" (about 120 db with the usual type of mixer wiring). There is an initial insertion loss of 6 db.

Type of Section: A ladder-type network is employed. Has advantage of only one sliding contact while maintaining essentially constant impedance.

Type of Winding: Resistors are wound on cylindrical spools which are part of the bakelite moulding.

Terminal Impedance: 50-, 200-, and 500-ohm units are carried in stock, but others can be built to order at a slight additional cost.

Shielding: An aluminum cover is a protection against dust and acts as an electrostatic shield.

Switch: A 3-bladed phosphor-bronze switch makes firm contact with bronze alloy contact points.

Terminals: Screw terminals are provided.

Dial Plate: A dial plate calibrated directly in decibels also serves as a drilling template in mounting volume control.

Knob: TYPE 637-K, with engraved white arrow.

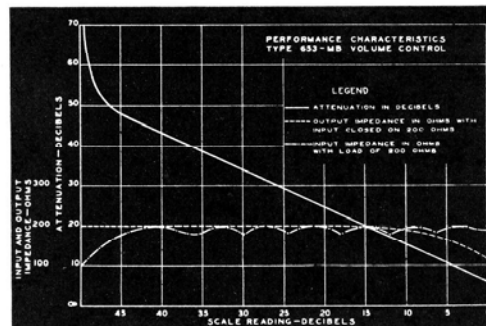

Mounting: The unit is arranged for panel mounting by means of two screws which are supplied. The volume control may be mounted on panels up to $\frac{3}{8}$ inch in thickness. Holes are spaced $1\frac{1}{2}$ inches apart.

Dimensions: Maximum over-all radius, $1\frac{3}{4}$ inches. Maximum depth behind panel, $2\frac{5}{8}$ inches. Shield diameter, $2\frac{3}{4}$ inches.

Net Weight: 13 ounces.

Type	Impedance	Code Word	Price
653-MA	50 Ω	CLUMP	\$12.50
653-MB	200 Ω	COACH	12.50
653-MC	500 Ω	COAST	12.50

TYPE 552 VOLUME CONTROL

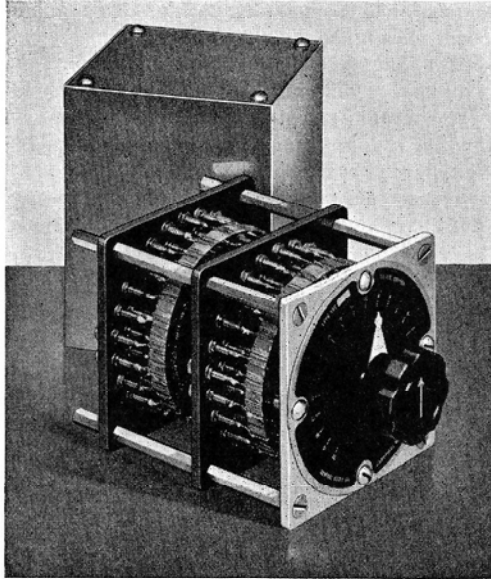

TYPE 552-HB

This unit has been designed primarily as a master gain control in high-grade broadcast transmission, sound-recording and projection, and public-address systems. Where the very finest equipment is being installed, its use is also recommended in mixer circuits. Because of its accuracy, excellent frequency characteristic, and compactness, it will be found useful in measuring circuits where the expense of our high-precision attenuation networks is not justified.

The design of the individual resistors makes a very rigid mechanical construction. The whole assembly is built to withstand the most severe service requirements.

No slide-wire contacts are used; the action is entirely step by step. This increases the reliability of the unit, at the same time making exact duplication of attenuation settings easily possible. The step-by-step contacts used in this volume control also have a slightly lower noise level than the best of sliding contact. Contacts have been run for 200,000 operations without showing signs of appreciable wear.

SPECIFICATIONS

Range: One range, 0 db to 30 db, in steps of 1.5 db is carried in stock, but special ranges can be built to order.

Type of Section: T-section and balanced-H-section models are available.

Type of Winding: Unifilar winding on bakelite strips as shown in the accompanying illustration.

Terminal Impedance: Units for working in 200-ohm and 500-ohm circuits are carried in stock, but others can be built to order.

Accuracy: All resistors are adjusted to within 2%, which makes the error in attenuation less than 1 db at all settings up to 20 kc.

Switch: A multiple blade switch is used.

Mounting: The entire unit is supported on a square aluminum sub panel that can be mounted on a panel by means of the same four machine screws that hold the etched-metal dial plates.

Terminals: A terminal strip mounted with soldering lugs is mounted behind the sub panel.

Dimensions: Sub panel, 4¼ x 4¼ inches; depth behind panel: 3, for T-section models; 5½ inches for balanced-H-section models.

Net Weight: 2 pounds for T-section, 3 pounds for balanced-H-section models.

Type	Attenuation	Impedance	Section	Code Word	Price
552-TB	30 db in steps of 1.5 db	200 Ω	T	ALIEN	\$28.00
552-TC	30 db in steps of 1.5 db	500 Ω	T	ALARM	28.00
552-HB	30 db in steps of 1.5 db	200 Ω	Balanced-H	ALBUM	48.00
552-HC	30 db in steps of 1.5 db	500 Ω	Balanced-H	AGAIN	48.00

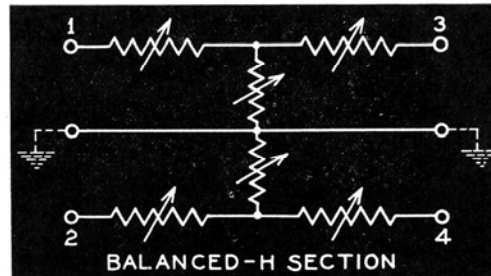
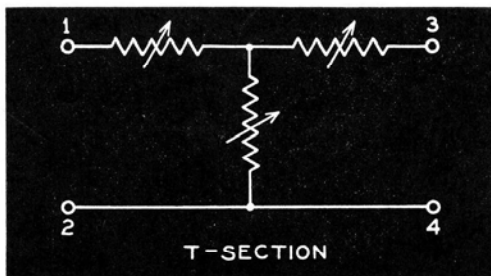

Both networks maintain constant impedance in both directions, but the balanced-H-section is used where the transmission circuit must be balanced to ground

TYPE 642-D VOLUME CONTROL

This high-impedance voltage-divider unit is intended for use as a gain control in the input circuit of a vacuum tube or as a multiplier for a vacuum-tube voltmeter. It is compact and ruggedly constructed, the contact noise level being sufficiently low to

permit of its use in the highest quality circuits. With sufficient care in keeping down the stray capacitances in the wiring between the volume control output and the socket, the

calibration is accurate to within 0.1 db at all frequencies up to 20,000 cycles.

Only one type is available in stock, but units having different values of impedance or of attenuation per step can be built to order. Designs are, in general, limited to a total of 10 steps. Prices on request.

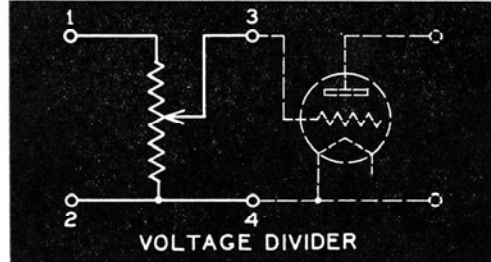
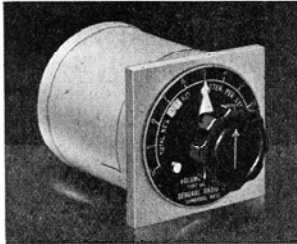

SPECIFICATIONS

Range: One range, 0 db to 30 db, in steps of 3 db is carried in stock, but other sizes can be built to order.

Type of Section: Voltage divider for working into a high-impedance circuit such as the grid of a tube.

Type of Winding: Individual random-wound, non-inductive resistors are used.

Terminal Impedance: The input impedance of the unit is 200,000 ohms when the switch side is connected across the grid-filament circuit of a vacuum tube or other essentially infinite-impedance load.

Accuracy: All resistors are adjusted to within 1%, which makes attenuation ratios accurate to within 0.1 db. If capacitance of tube, socket, and wiring is less than 20 μmf , as is usually the case, the rated accuracy limit of 0.1 db holds to approximately 20,000 cycles.

Maximum Current: Although normally used in circuits drawing no current, a current of 4 ma will not cause a temperature rise sufficient to affect the rated accuracy.

Switch: The switch arm is constructed of four-leaf phosphor bronze, which provides for long wear and exceptionally low contact noise. The cam-type detent may be easily removed if smooth switch action is required.

Mounting: This unit is similar in construction to the TYPE 510 Decade-Resistance Units. The form supporting the resistors and the switch is made of moulded bakelite, and this is attached to a panel by the same two screws which hold the etched-metal dial plate as in TYPE 510 Decade-Resistance Units.

Terminals: Three soldering lugs are placed at the end of the unit for making connections, and the shield has a small opening for connecting wires.

Dimensions: Shield diameter, 3 $\frac{1}{16}$ inches; depth behind panel, 3 $\frac{1}{16}$ inches.

Net Weight: 16 ounces.

Type	Attenuation		Impedance	Code	
	Total	Steps		Word	Price
642-D	30 db	3 db	200,000 Ω	EXALT	\$25.00

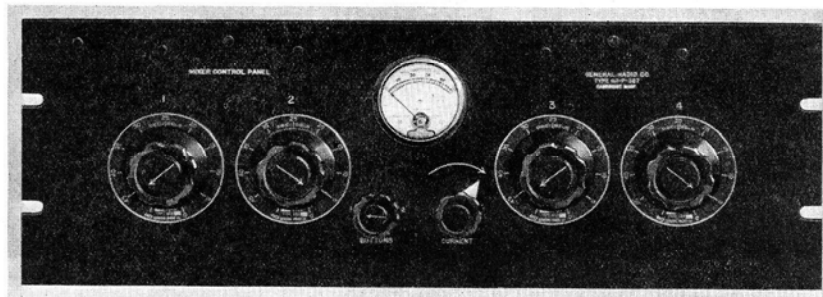

A four-channel mixer panel assembled from TYPE 653 Volume Controls

RHEOSTAT-POTENTIOMETERS (VOLTAGE DIVIDERS)

The complete line of adjustable resistors described on the following pages is the direct outgrowth of the need for filament-current controls in vacuum-tube circuits. Other applications are found in all kinds of electrical apparatus where vacuum tubes, resistance bridges and thermocouples are involved.

Units are available from stock with power-dissipation ratings as high as 250 watts and maximum-resistance ranges extending from 0.75 ohm to 200,000 ohms.

Because of the "straight through" shaft construction, these rheostat-potentiometers may be ganged up on the same shaft to provide simultaneous variations of many separate elements under single control. Complicated fader networks may be built up by using flexible couplings or by the substitution of a single shaft of insulating material passing through all of the controls.

All but largest and smallest types are interchangeable on the standard three-hole mounting shown below. When ganged, they may be set up back to back on either side of a sheet support.



AS PANEL-MOUNTING MODELS

Every General Radio rheostat-potentiometer is furnished ready for panel mounting, as shown in the above photograph, but every type except one (TYPE 410) can, by a few moments' work with a screwdriver, be converted for top-of-table mounting as shown on the following pages in photographs accompanying the detailed description of each unit.

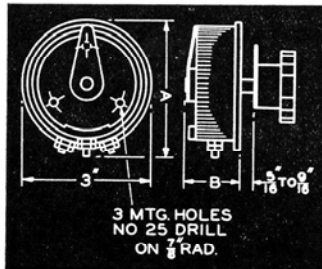

Standard 3-hole mounting method for rheostat-potentiometers

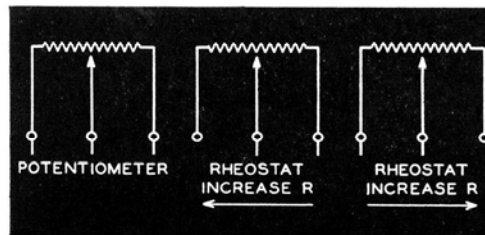

Any potentiometer can also be used as a rheostat for either direction of rotation. There is no off position

TYPE 371 RHEOSTAT-POTENTIOMETER



Rheostat-potentiometers in this series have their resistors wound on a thin linen-bakelite strip which is then bent around the bakelite supporting form. The contact arm is a single blade that wipes the edge of the resistor.

Allowable power dissipation is 20 watts.

Values of maximum resistance between 1 ohm and 50,000 ohms can be supplied from stock, but others within the power-rating limit can be built to order.

In addition to the so-called "linear" units in which resistance is proportional to the angle through which the blade has turned, a unit having a tapered winding is available. In this (TYPE 371-T) the resistance is approximately proportional to the square of the angle, increasing with clockwise rotation of the knob in a panel-mounted unit. Other resistor shapes can be made to order.

SPECIFICATIONS

Power Rating: 20 watts; TYPE 371-T, 8 watts.

Rotation Angle: 303° (approx.). No OFF position.

Shaft: Steel, 1/4-inch diameter.

Knob: TYPE 637-G.

Mounting: Standard 3-hole; machine screws, nuts, and template furnished. Supplied as panel type, easily converted for table mounting.

Dimensions: See sketch on preceding page: A = 3 1/8, B = 2 1/2 inches.

Net Weight: 6 ounces.

Type	Maximum Resistance	Maximum Current	Code Word	Price
371-A	1 Ω	4.5 a	RALLY	\$4.00
371-A	5 Ω	2.0 a	RELAY	4.00
371-A	1000 Ω	140 ma	REDAN	4.00
371-A	2500 Ω	90 ma	REFIT	4.00
371-A	5000 Ω	60 ma	ROTOR	4.00
371-A	10,000 Ω	45 ma	ROWDY	4.00
371-A	18,000 Ω	30 ma	RULER	4.00
371-A	50,000 Ω	20 ma	SATYR	4.00
*371-T	10,000 Ω	28 ma	SULLY	4.00

*Tapered model.

TYPE 214-A RHEOSTAT-POTENTIOMETER

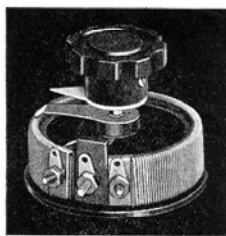

This unit has the same type of construction as the TYPE 371 Rheostat-Potentiometer described above, except that the winding form is narrower and the power rating and maximum resistance values are, accordingly, smaller.

The resistor is wound on a linen-bakelite strip and the contact member is a single blade that wipes the edge of the winding. Maximum power dissipation is conservatively placed at 9 watts, values of current corresponding to which are given in the price list. Maximum resistance values range from 0.75 to 2500 ohms, but other sizes within the power-rating limit can be built to order.

Units of this type are more suitable for battery-operated installations where space is at a premium or where critical filament potentials must be maintained.

SPECIFICATIONS

Power Rating: 9 watts, see current rating below.

Rotation Angle: 315°. No OFF position.

Shaft: Steel, 1/4-inch diameter.

Knob: TYPE 637-G.

Mounting: Standard 3-hole; machine screws, nuts, and template furnished. Supplied as panel type, easily converted for table mounting.

Dimensions: See sketch on preceding page: A = 3 1/4, B = 1 1/4 inches.

Net Weight: 5 ounces.

Type	Maximum Resistance	Maximum Current	Code Word	Price
214-A	0.75 Ω	3.5 a	SHINY	\$1.50
214-A	2 Ω	2.1 a	RUDDY	1.50
214-A	7 Ω	1.1 a	RURAL	1.50
214-A	20 Ω	0.67 a	RAZOR	1.50
214-A	50 Ω	425 ma	RAPID	1.50
214-A	100 Ω	300 ma	RIVET	1.50
214-A	200 Ω	210 ma	EMPTY	1.50
214-A	400 Ω	160 ma	ROBIN	1.50
214-A	1000 Ω	95 ma	ENACT	1.50
214-A	2500 Ω	60 ma	SYRUP	1.50

TYPE 471-A RHEOSTAT-POTENTIOMETER

This rheostat-potentiometer is one of two types that have constructional features which adapt them for use in high-impedance vacuum-tube circuits. The requirements for this service are severe in that not only must the unit itself have a high resistance, but, because of the low power levels and amplification of all disturbances by the later stages, no contact noise can be tolerated.

In order to meet these requirements the high resistance is obtained by winding the card with fine wire and then protecting it externally from mechanical damage or derangement of the turns by means of a securely anchored band of linen bakelite.

Low noise levels are assured through the use of a contact arm bearing four separate wiping fingers whose average contact resistance is essentially constant for any position of the knob. The unit may be mounted directly on a

metal panel without the necessity of insulating bushings, for the insulated shaft removes all possibility of short circuits as well as any hum that would be introduced by the operator's hand.

The winding form has the same diameter with a slightly greater depth than that of the TYPE 371 Rheostat-Potentiometer described on the opposite page, but the allowable power dissipation is smaller because of the bakelite protecting strip. Values of total resistance as high as 200,000 ohms are available. Special sizes or tapered models with various characteristics can be built to order.

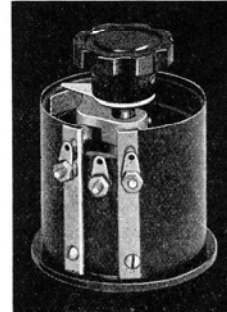

SPECIFICATIONS

- Power Rating:** 12 watts.
- Rotation Angle:** 294° (approx.). No OFF position.
- Shaft:** Bakelite, 3/8-inch diameter.
- Knob:** TYPE 637-H.
- Mounting:** Standard 3-hole; machine screws, nuts, and template furnished. Supplied as panel type, easily converted for table mounting.
- Dimensions:** See sketch on second preceding page: A = 3 1/8, B = 2 5/8 inches.
- Net Weight:** 9 ounces.

Type	Maximum Resistance	Maximum Current	Code Word	Price
471-A	100 Ω	330.0 ma	EQUIP	\$6.00
471-A	1000 Ω	104.0 ma	ERASE	6.00
471-A	10,000 Ω	33.0 ma	ERECT	6.00
471-A	50,000 Ω	14.7 ma	ERODE	6.00
471-A	100,000 Ω	10.4 ma	ERUPT	6.00
471-A	200,000 Ω	7.3 ma	ESKER	6.00

TYPE 314-A RHEOSTAT-POTENTIOMETER

Of the same mechanical and electrical design as the TYPE 471-A Rheostat-Potentiometer described above, this unit differs from it in having the shorter winding form. It has the protected resistor, the bakelite shaft, and the 4-finger contact arm.

The winding form has the same depth, diameter, and arrangement of mounting holes as the TYPE 214-A Rheostat-Potentiometer described at the bottom of the opposite page,

but because the winding is protected, the allowable power dissipation is smaller. Resistances as high as 20,000 ohms are available from stock, and special sizes within the power-rating limit can be built to order.

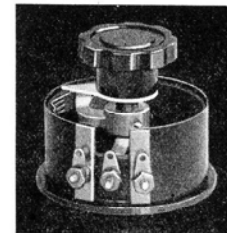

SPECIFICATIONS

- Power Rating:** 6 watts.
- Rotation Angle:** 294° (approx.). No OFF position.
- Shaft:** Bakelite, 3/8-inch diameter.
- Knob:** TYPE 637-H.
- Mounting:** Standard 3-hole; machine screws, nuts, and template furnished. Supplied as panel type, easily converted for table mounting.
- Dimensions:** See sketch on second preceding page: A = 3 1/4, B = 1 3/8 inches.
- Net Weight:** 6 ounces.

Type	Maximum Resistance	Maximum Current	Code Word	Price
314-A	200 Ω	165 ma	ENATE	\$4.00
314-A	600 Ω	95 ma	ENDOW	4.00
314-A	2000 Ω	52 ma	ENEMY	4.00
314-A	6000 Ω	30 ma	ENJOY	4.00
314-A	20,000 Ω	16 ma	ENROL	4.00

TYPE 533-A RHEOSTAT-POTENTIOMETER

This is a heavy-duty unit, which can dissipate 250 watts under continuous load. The frame is of moulded bakelite, and the resistance element is wound on an asbestos-covered aluminum strip that serves to distribute the heat to be dissipated to all portions of the element for better radiation. This unit, and the one listed below, should not be used in closed compartments or where a means of ventilation has not been provided to keep the temperature of associated apparatus at a reasonable value.

Both types are equipped with three TYPE 138-V combination binding post and plug jacks set on standard spacing so that tight plug-in connections may be made to obtain immediately a rheostat of either direction of rotation for increased resistance, or a fixed resistance from which a variable tap is to be taken.

Seven maximum resistance values are carried in stock but others of the same power rating can be built to order.

SPECIFICATIONS

Power Rating: 250 watts, see current rating below.
Rotation Angle: 305° (approx.). No OFF position.

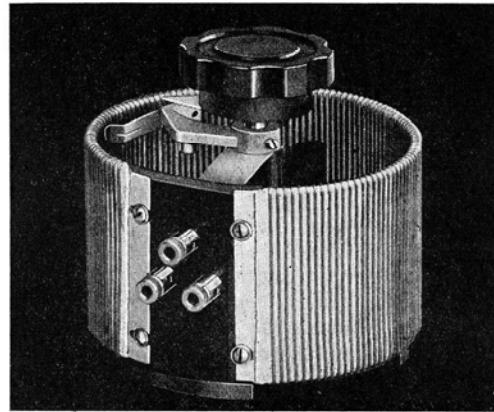

Shaft: Steel, $\frac{3}{8}$ -inch diameter.

Knob: TYPE 637-Q.

Mounting: Table type supplied, easily converted for panel mounting; see accompanying sketch. Machine screws, nuts, and a drilling template are furnished.

Dimensions: See accompanying sketch.

Net Weight: 1 $\frac{7}{8}$ pounds.

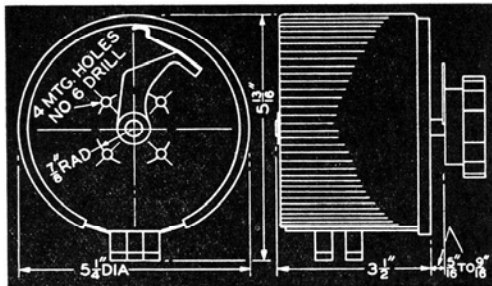

Type	Maximum Resistance	Maximum Current	Code Word	Price
533-A	1 Ω	15.8 a	MOLAR	\$6.00
533-A	3 Ω	9.1 a	MONAD	6.00
533-A	10 Ω	5.0 a	MORAL	6.00
533-A	30 Ω	2.9 a	MOTTO	6.00
533-A	100 Ω	1.6 a	MUGGY	6.00
533-A	300 Ω	0.9 a	MUMMY	6.00
533-A	600 Ω	0.6 a	MUSTY	6.00

TYPE 333-A RHEOSTAT-POTENTIOMETER



This unit, although smaller, has the same constructional features as the TYPE 533-A Rheostat - Potentiometer described above. It has the standard 3-hole mounting which makes it interchangeable with the units shown on the next page.

Its power dissipation rating is 100 watts.

SPECIFICATIONS

Power Rating: 100 watts.
Rotation Angle: 289° (approx.). No OFF position.

Shaft: Steel, $\frac{3}{8}$ -inch diameter.

Knob: TYPE 637-H.

Mounting: Standard 3-hole; machine screws, nuts, and template furnished. Supplied as panel type, easily converted for table mounting.

Dimensions: See sketch on third preceding page: A = 4, B = $2\frac{5}{8}$ inches.

Net Weight: 11 ounces.

Type	Maximum Resistance	Maximum Current	Code Word	Price
333-A	1 Ω	10.0 a	VALOR	\$4.00
333-A	3 Ω	5.8 a	VAPID	4.00
333-A	10 Ω	3.2 a	VENUS	4.00
333-A	30 Ω	1.9 a	VIGIL	4.00
333-A	100 Ω	1.0 a	VIGOR	4.00
333-A	300 Ω	0.6 a	VILLA	4.00
333-A	600 Ω	0.4 a	VIPER	4.00

TYPE 301-A RHEOSTAT-POTENTIOMETER



Rated at a maximum power dissipation of 5 watts, this is the smallest rheostat-potentiometer we manufacture. Because of its compactness it is ideal for filament controls on small tubes.

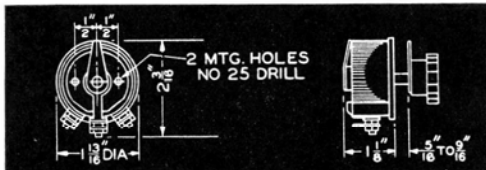

SPECIFICATIONS

Power Rating: 5 watts; 3 watts on 10,000 Ω and 20,000 Ω models.

Rotation Angle: 254° (approx.). No OFF position.

Shaft: Steel, 1/4-inch diameter. **Knob:** TYPE 637-A.

Mounting: Panel type supplied; easily converted for table mounting. Machine screws, nuts, and template furnished.

Dimensions: See accompanying sketch.
Net Weight: 3 ounces.

Type	Maximum Resistance	Maximum Current	Code Word	Price
301-A	6 Ω	1 a	PALSY	\$1.00
301-A	12 Ω	0.7 a	REMIT	1.00
301-A	25 Ω	0.5 a	RENEW	1.00
301-A	200 Ω	175 ma	REBUS	1.00
*301-A	10,000 Ω	17 ma	CURRY	1.50
*301-A	20,000 Ω	12 ma	CRUMB	1.50

*Supplied with linen-bakelite protecting strip.

TYPE 410-A RHEOSTAT-POTENTIOMETER



This is identical with the TYPE 301-A Rheostat-Potentiometer described above, except that it is equipped for single-hole mounting, often a convenient feature. This unit cannot ordinarily be used on metal panels.

SPECIFICATIONS

Power Rating: 5 watts.
Rotation Angle: 254° (approx.). No OFF position.
Shaft: Steel, 1/4-inch diameter. **Knob:** TYPE 637-A.
Mounting: Single-hole panel type only.
Dimensions: See accompanying sketch.
Net Weight: 3 ounces.

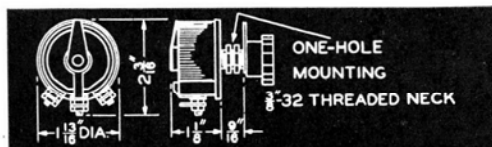

Type	Maximum Resistance	Maximum Current	Code Word	Price
410-A	6 Ω	1 a	SABOT	\$1.00
410-A	12 Ω	0.7 a	SALON	1.00
410-A	25 Ω	0.5 a	SALTY	1.00
410-A	200 Ω	175 ma	SATIN	1.00

TYPE 437 and TYPE 439 CENTER-TAP RESISTANCE UNITS

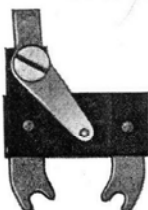

TYPE 437

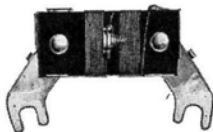

TYPE 439

SPECIFICATIONS

Resistance: 60 ohms.
Maximum Current: 200 ma.
Dimensions: TYPE 437, 1 3/4 x 1 1/2 x (thickness) 3/8 inches. TYPE 439, 1 3/8 x 1 1/4 x (thickness) 5/8 inches.
Net Weight: 1/2 ounce.

These two units mount directly on the terminals of a General Radio tube socket, offering a means of connecting a grid- or plate-return lead to the mid-potential point of the filament or heater. TYPE 437 has the adjustable mid-point.

Type	Center Tap	Code Word	Price
437	Adjustable	PERIL	\$0.50
439	Fixed	PASTY	.35

VARIAC*

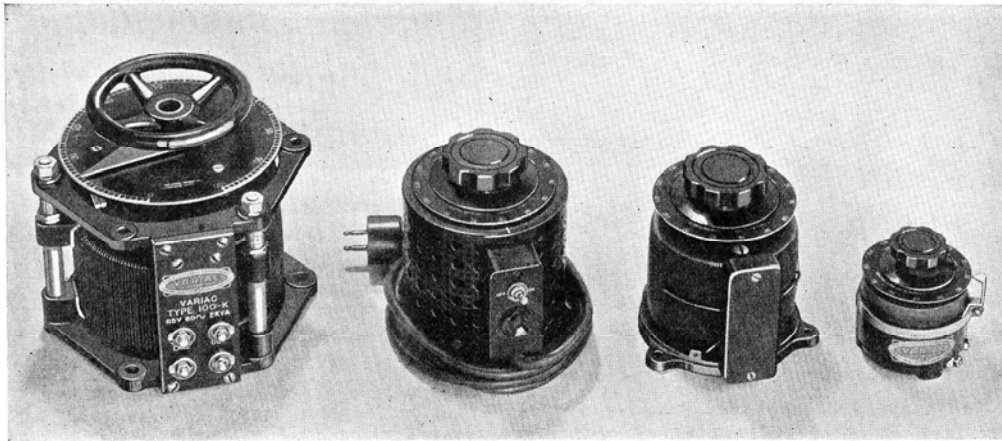

TYPE 100-K

TYPE 200-CM

TYPE 200-CU

TYPE 200-B

The Variac is an adjustable transformer that delivers any voltage between zero and line voltage with as smooth and uninterrupted control as that obtainable from any rheostat. (On one model any voltage between zero and 135 volts can be obtained from the 115-volt, 60-cycle line.)

The applications of the Variac to industrial control and to experimental problems in the laboratory are literally numberless. In general, it can be stated that the Variac is the ideal a-c voltage control device because of its high efficiency, low heat dissipation, and good voltage regulation. It has many advantages over the usual rheostat or potentiometer. The output voltage is essentially independent of load. Voltages in the vicinity of zero are obtainable, and it is possible to increase the voltage and thus provide a means of compensating for low line voltage.

This combination of qualities has been obtained by means of design features of considerable interest. The Variac in its simplest form consists of a laminated iron core built up of toroidal punchings. A single-layer winding traversed by a moving blade provides both the transformer effect and a convenient means of voltage adjustment. Since each turn of the winding can be reached by the switch, a continuous adjustment of voltage is obtained. The transformers are designed to have about 0.25 to 0.5 volt between turns. A carbon brush on the switch limits the current in the short-circuited turn so that no undue heating results.

*Registered in U. S. Patent Office.

The following are a few suggested uses:

Voltage Control on Rectifier Systems —

A power pack for supplying dc to vacuum tubes with a Variac in the primary of the supply transformer gives d-c voltage control over the complete range with equally low percentage regulation at all output voltages.

Over- and Under-Voltage Testing — Operating tests on radio receivers and other socket-power household devices are facilitated.

Low Line Voltage Compensation — Line voltage can be restored to normal when, because of heavy loading or a long line, full voltage cannot be obtained otherwise.

Meter Calibration — Calibration, by comparison with a standard, of a-c voltmeters and ammeters.

Motor Speed Control — The Variac is a convenient means of adjusting speed on small voltage-sensitive motors like those used on jewelers' lathes.

Theater-Lighting Control — Especially useful on "little theater" and drama-club stages.

Soldering Iron Control — Economical maintenance of operating temperature. One can heat a cold iron quickly by applying over-voltage.

Photoflood Lamps — Photographers use the Variac to reduce brilliancy during preliminary adjustments and lengthen lamp life.

Transformer Testing — Variac control in transformer primary circuits eliminates the third harmonic component of output voltage that is present when magnetizing current flows in a resistive control.

The Variac is carried in stock in the five types described in the following specifications. We can, however, build on order other sizes within the limits imposed by available core structures. Prices will be furnished on request.

SPECIFICATIONS

Load Rating: The value of "Load Rating" specified in the price list for each model is the full-voltage volt-ampere rating of a constant-impedance load. In other words, TYPE 100-K will control at any setting a bank of lamps rated 2 kva at 115 volts.

Current: The "Rated Current" specified in the price list can be drawn safely at any point in the output-voltage range, but at some settings this rated value of load current may be exceeded. This increased current is the "Maximum Current" given in the price list.

Since the Variac is an auto-transformer, maximum loss (which determines the rating) occurs at one-half line voltage. In the vicinity of full-line voltage, however, there is no transformer action, and the allowable current is limited only by heating in the brush, which permits the "Maximum Current" rating at this point.

Consequently, a Variac can handle, for any setting, a constant-impedance load (such as a bank of lamps) which draws at full voltage a current no greater than the specified "Maximum Current."

Calibration: Dials giving a voltage calibration accurate to $\pm 2\%$ when the line voltage has its rated value are furnished on all but TYPES 100-K and 100-L. These two have a 100-division dial plate which gives an approximate calibration, as the indicated percentage of line voltage.

Knob: TYPES 100-K and 100-L have a hand wheel with a fixed dial plate.

TYPES 200-B, 200-CM, and 200-CU have dials permanently attached to TYPE 637 Knobs.

Voltage increases with clockwise rotation of the control wheel on TYPES 100-K and 100-L. On TYPES 200-B, 200-CM, and 200-CU voltage increases with counter-clockwise rotation of the dial when arranged for table mounting.

Direction of rotation for increased voltage may be reversed by a change of connections on TYPES 200-B, 200-CM, and 200-CU, but not on TYPES 100-K or 100-L.

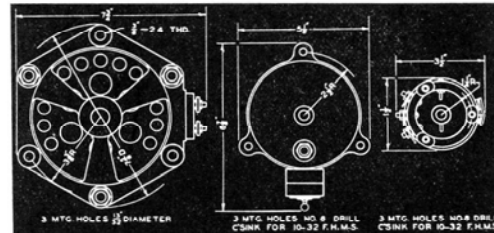

100-K, -L 200-CM, -CU 200-B
VARIAC TYPES

Terminals: TYPE 100-K and TYPE 100-L have threaded terminal studs and are supplied with soldering lugs.

TYPE 200-B has threaded terminal studs, nuts on which hold soldering lugs.

TYPE 200-CM is furnished complete with attachment cord and plug for the input connection to the mains, an ON-OFF switch, and a standard plug receptacle for the output circuit.

TYPE 200-CU is provided with soldering lugs placed inside the bakelite housing.

Mounting: All models are readily converted from the table mounting illustrated to back-of-panel mounting. TYPES 100-K and 100-L can be mounted back-to-back in cascade for operation by a single shaft. See accompanying drawing for mounting dimensions.

TYPES 100-K, 100-L, 200-CU, and 200-B are supplied without a case. TYPE 200-CM has a protecting case.

Dimensions: See sketch. Over-all height: TYPE 100-K, $7\frac{3}{8}$; TYPE 100-L, 8; TYPE 200-B, $3\frac{3}{4}$; and TYPES 200-CM and 200-CU, $5\frac{1}{2}$ inches.

Net Weight: TYPE 100-K, $20\frac{5}{8}$; TYPE 100-L, $23\frac{3}{4}$; TYPE 200-B, $2\frac{3}{4}$; TYPE 200-CM, 10; and TYPE 200-CU, 9 pounds.

Type	Load Rating	Primary Voltage*	Current		Output Voltage	Code Word	Price
			Rated	Maximum			
100-K	2 kva	115 v	15 a	17 a	0-115 v	BEAMY	\$40.00
100-L	2 kva	230 v	8 a	9 a	0-230 v	BEARD	40.00
200-B	170 va	115 v	1 a	1.5 a	0-115 v	BALSA	10.00
200-CM	850 va	115 v	5 a	7.5 a	0-130 v	BALMY	17.50
200-CU	850 va	115 v	5 a	7.5 a	0-130 v	BAKER	14.50

*50-60 cycles, ac only.

TYPE 539 VARIABLE AIR CONDENSER (UNMOUNTED MODELS)

This is a high-grade laboratory-type condenser that is used in many laboratories where permanently assembled experimental equipment is being built. It has the lowest losses of any General Radio laboratory-type condenser and these losses remain practically constant with setting.

Three brass rods, extensions of which serve as mounting pillars, rigidly support the two end plates on each of which is a block of isolantite carrying the two rods to which the stator is attached. This construction facilitates the use of special plate shapes, like those in the TYPE 539-T (straight-line frequency, 270° angle of rotation) Condenser and the TYPE 539-X which is used to spread out the scale of beat-frequency oscillators.

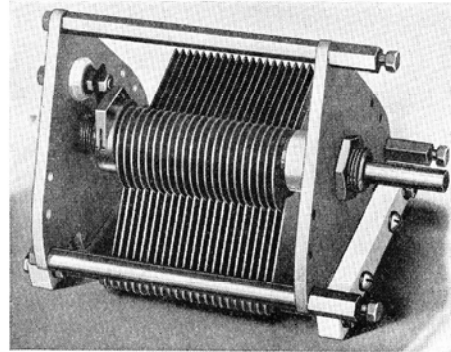

This TYPE 539-TA Condenser is of interest because the entire rotor assembly (as well as the stator) is insulated from the end plates

SPECIFICATIONS

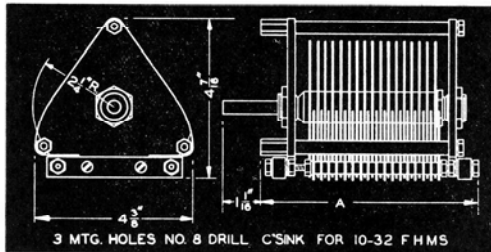

Capacitance Range: See price list.

Plate Shape: Semicircular rotor plates giving linear capacitance variation with setting are used on TYPES 539-J, 539-K, and 539-L.

Rotor plates for TYPES 539-T and 539-TA are cut to give a linear frequency variation with setting over 250° of a possible 270° angle of rotation when a capacitance of 25 $\mu\mu\text{f}$ is connected in parallel with the condenser. They are assembled on the shaft so that counter-clockwise rotation produces an increase in frequency. The resulting frequency ratio is 3:1 starting from a setting corresponding to a condenser capacitance of 33 $\mu\mu\text{f}$, approximately.

TYPE 539-X has a spread-out scale for use on a beat-frequency oscillator. When it is used in a beat-frequency oscillator having a carrier in the vicinity

of 165 kc and an associated zero capacitance of 1500 $\mu\mu\text{f}$, a frequency range of from 0–10,000 cycles is covered by approximately 230° on the dial: 0–100 cycles is covered by 40°, 100–1000 cycles by 50°, and 1000–10,000 cycles by 140°, approximately.

Supports: Two bars of isolantite, treated to prevent absorption of moisture, support the stator assembly.

Low Losses: $R\omega C^2$ is approximately 0.03×10^{-12} .

Maximum Voltage: TYPE 539-J is conservatively rated at 1100 volts, peak; TYPE 539-K at 800 volts, peak; and TYPES 539-L, 539-T, 539-TA, and 539-X at 550 volts, peak.

Knobs and Dials: None are supplied. Note that all models have $\frac{3}{8}$ -inch shafts and that TYPES 539-T and 539-TA require a scale spread over 270°, instead of the 180° required by the other types.

Terminals: Soldering lugs are mounted on the lower isolantite support of all except TYPE 539-TA. The rotor connection for this condenser is brought out through an isolantite bushing in the rear end plate.

Mounting: See accompanying outline drawing.

Dimensions: See accompanying outline drawing.

Net Weight: Approximately 2 $\frac{3}{4}$ pounds.

Type	Nominal Capacitance		Description	Code Word	Price
	Maximum	Minimum			
539-J	500 $\mu\mu\text{f}$	50 $\mu\mu\text{f}$	Straight-line capacitance	ATLAS	\$10.00
539-K	1000 $\mu\mu\text{f}$	55 $\mu\mu\text{f}$	Straight-line capacitance	ATONE	11.00
539-L	2000 $\mu\mu\text{f}$	60 $\mu\mu\text{f}$	Straight-line capacitance	ATTIC	12.00
539-T	500 $\mu\mu\text{f}$	30 $\mu\mu\text{f}$	Straight-line frequency	CLOSE	12.00
539-TA	500 $\mu\mu\text{f}$	30 $\mu\mu\text{f}$	Straight-line frequency, insulated rotor	CLOTH	15.00
539-X	900 $\mu\mu\text{f}$	50 $\mu\mu\text{f}$	Special spread-out scale	AUGER	12.00

TYPE 568 VARIABLE AIR CONDENSER

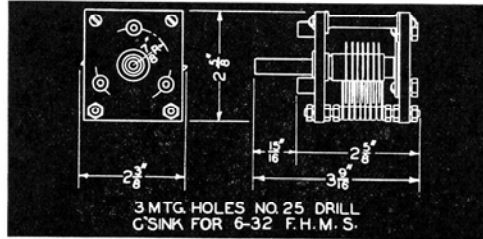
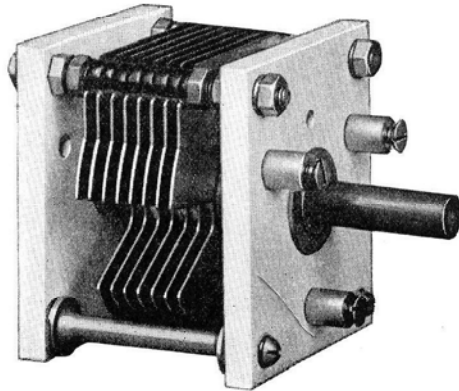

SPECIFICATIONS

Plate Shape: Straight-line capacitance for TYPE 568-D; approximately straight-line frequency for TYPE 568-K.

Supports: End plates are of isolantite, treated to prevent moisture absorption.

Low Losses: $R\omega C^2$ is approximately 0.03×10^{-12} .

Maximum Voltage: 500 volts, peak.

Knobs: None supplied. Shaft diameter, $\frac{3}{8}$ -inch; rotation angle 180° for TYPE 568-D, 270° for TYPE 568-K.

Mounting: See accompanying sketch. Drilling template and 3 flat-head screws are furnished.

Dimensions: See sketch.

Net Weight: $\frac{3}{4}$ pound.

This is a condenser of rugged construction for use as a tuning element in short-wave receivers, transmitters, and wavemeters. It is designed for tandem mounting, a hollow shaft permitting the use of a single long bakelite or metal shaft for driving several units. The isolantite end plates help to keep the losses at a minimum. Contact to the rotor is made through an eight-fingered conical bearing kept under heavy spring pressure, and, in order to reduce resistance, each plate stack is soldered into an integral piece before assembly.

Two sizes are available, one of 175- $\mu\mu\text{f}$ with straight-line capacitance plates and the other of 50- $\mu\mu\text{f}$ with straight-line frequency plates.

Type	Nominal Capacitance		Code Word	Price
	Maximum	Minimum		
568-D	175 $\mu\mu\text{f}$	12 $\mu\mu\text{f}$	CLOVE	\$4.00
568-K	50 $\mu\mu\text{f}$	12 $\mu\mu\text{f}$	CLOUD	4.00

SPECIAL CONDENSERS FOR SPECIAL NEEDS

We are equipped to build to order condensers with values of maximum capacitance other than those of the stock models described here. Non-semicircular plate shapes include those to give accurate straight-line-frequency scales or to give a logarithmic output-frequency scale in

beat-frequency oscillators. The addition of circular rotor plates will produce condensers with band-spread characteristics, variable within a fixed range, without the use of trimmer or padding capacitances. Shafts, shields, and insulating materials are supplied to specifications.

PATENT NOTICE. General Radio Condensers which incorporate the following special features are manufactured under United States Patents as noted: Soldered plates, No. 1,542,995; plates other than of semicircular shape, No. 1,258,423; plates with wide angle of rotation. No. 1,525,778.

TYPES 334 and 335 VARIABLE AIR CONDENSERS

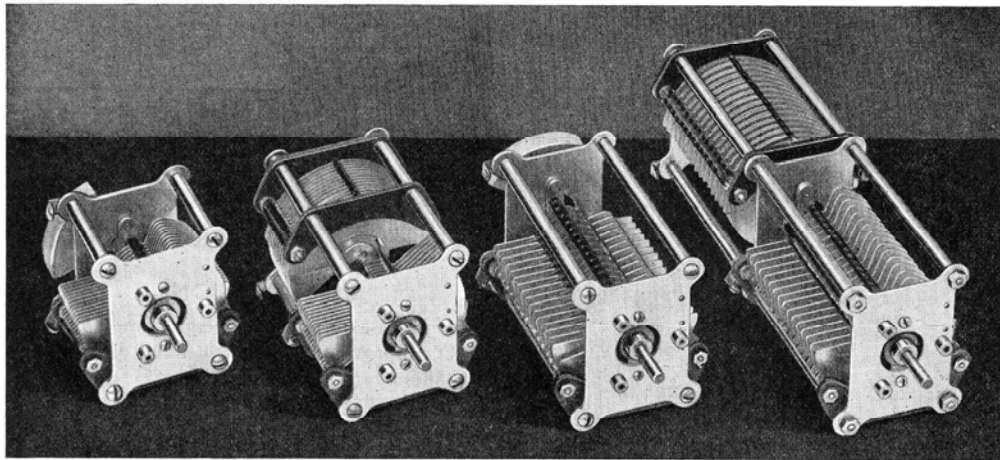

Left to right: TYPE 334-F, TYPE 335-Z, TYPE 334-R, and TYPE 334-Z

This group of condensers is available in a variety of sizes for general experimental use. They have soldered brass plates and metal end plates which are grounded to the rotor stack and to the shaft. Insulation is of hard rubber.

Models rated in the price list at 1500 volts, peak, have double the plate spacing of those rated at 500 volts, peak. The former are intended for use in power oscillators or intermediate stages of medium-power transmitters.

SPECIFICATIONS

Plate Shape: Approximately straight-line wavelength for all except TYPE 335-Z which has straight-line capacitance plates.

Supports: Two small sections of first-quality hard rubber support the stator.

Low Losses: $R\omega C^2$ is approximately 0.07×10^{-12} .

Knobs and Dials: None are supplied. Shaft diameter, $\frac{1}{4}$ inch; rotation angle, 180° for all sizes.

Types 334-Z and 335-Z have balanced rotors; all others, a counterweight.

Mounting: Standard General Radio 3-hole mounting. See accompanying sketch. Drilling template and 3 flat-head screws are furnished.

Four removable feet are furnished with each of the high-voltage models.

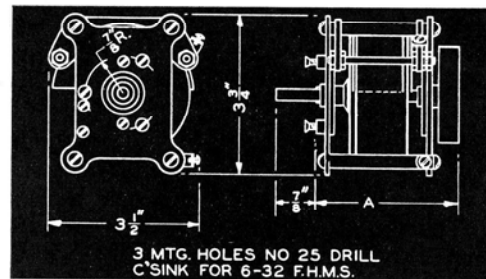

Terminals: See illustration.

Dimensions: See accompanying outline drawing. Depth (dimension A) is given in the price list.

Type	Nominal Capacitance		Maximum Peak Voltage	Depth (A)	Net Weight	Code Word	Price
	Maximum	Minimum					
335-Z	1150 μmf	50 μmf	500 v	5 $\frac{1}{4}$ in.	2 $\frac{1}{8}$ lb	BOGUS	\$6.00
334-F	500 μmf	20 μmf	500 v	3 $\frac{5}{16}$ in.	1 $\frac{1}{2}$ lb	BEGIN	3.25
334-N	350 μmf	20 μmf	500 v	3 $\frac{1}{8}$ in.	1 $\frac{3}{8}$ lb	BESET	3.00
334-K	250 μmf	15 μmf	500 v	2 $\frac{5}{8}$ in.	1 lb	BELOW	2.75
334-Z	500 μmf	35 μmf	1500 v	10 $\frac{1}{8}$ in.	3 $\frac{3}{8}$ lb	BOGEY	10.00
334-R	250 μmf	30 μmf	1500 v	6 $\frac{1}{2}$ in.	2 lb	BISON	5.50
334-T	100 μmf	15 μmf	1500 v	3 $\frac{1}{4}$ in.	1 $\frac{1}{8}$ lb	BILLY	2.75
334-V	50 μmf	10 μmf	1500 v	2 $\frac{5}{8}$ in.	$\frac{5}{8}$ lb	BIPED	2.50

TYPE 639-A VARIABLE AIR CONDENSER

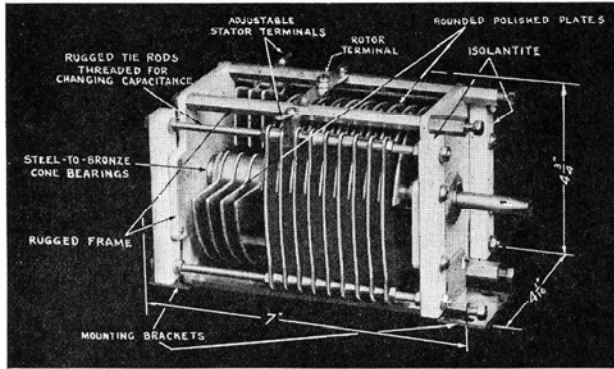

This condenser is of the double-section, high-voltage type for use in power oscillators. It has 3/16-inch aluminum end plates, large hexagonal tie-rods, and self-aligning conical bearings. The insulation is of isolantite.

Either section of the condenser can be readily taken apart and one or more plates shifted from one section to the other, thereby adjusting the capacitance, as for optimum excitation ratio in Colpitts oscillator circuits.

SPECIFICATIONS

Capacitance Range: Two sections are provided. Maximum capacitance of either section is readily adjustable from 25 μmf to 305 μmf , or the condenser may be used as a single-section type having a maximum capacitance of 330 μmf .

Plate Shape: Semicircular rotor plates, giving a linear capacitance variation with setting, and requiring a dial with a scale spread over 180°.

Plate Spacing: 0.098 inch.

Isolantite Supports: Four bars of isolantite, treated to prevent absorption of moisture, support the stator assembly.

Low Losses: $R\omega C^2$ is approximately 0.03×10^{-12} .

Maximum Voltage: 3500 volts, peak.

Dimensions: Panel space, 4 3/4 x 4 1/4 inches, overall; depth behind panel, 7 inches; shaft length measured from back of panel, 1 inch.

Knob: None supplied. Shaft diameter, 3/8 inch, rotation angle 180°.

Mounting: Four nickel-plated hex-head bolts and two mounting brackets with machine screws are supplied for either back of panel or table mounting.

Net Weight: 3 3/4 pounds.

Type	Code Word	Price
639-A	BARGE	\$17.50

TYPE 247 VARIABLE AIR CONDENSER

This is an experimental-type condenser having soldered brass plates and hard-rubber end plates.

SPECIFICATIONS

Plate Shape: Approximately straight-line wavelength.

Supports: Two plates of first-grade hard rubber support the assembly.

Low Losses: $R\omega C^2$ is approximately 0.08×10^{-12} .

Maximum Voltage: 500 volts, peak.

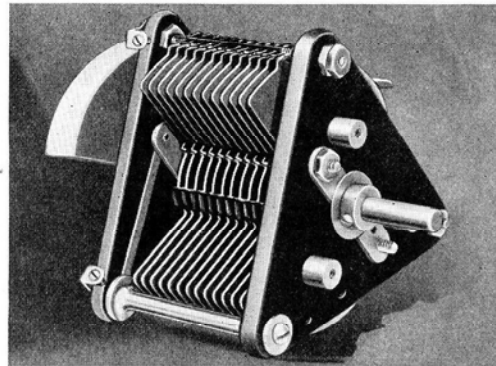

Dimensions: See sketch. Over-all depth behind panel, 3 3/8 inches.

Net Weight: 1 3/8 pounds.

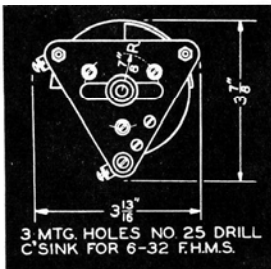

Knob: None supplied. Shaft diameter, 1/4 inch; rotation angle 180°.

Terminals: See illustration.

Mounting: See sketch. Drilling template and 3 flat-head screws furnished.

Type	Nominal Capacitance		Code Word	Price
	Maximum	Minimum		
247-F	500 μmf	20 μmf	COCOA	\$3.00

TYPE 368 VARIABLE AIR CONDENSER

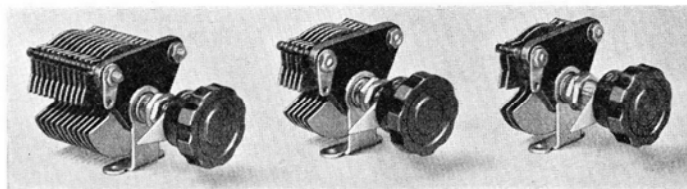

TYPE 368-C

TYPE 368-B

TYPE 368-A

This condenser is useful as a balancing or vernier condenser in various vacuum-tube cir-

uits, and many amateurs use it as a tuning condenser in receivers for the high-frequency (short-wave) bands. It has a single, hard-rubber end plate, single bearing, and can be used for single-hole panel mounting as well as for mounting on a baseboard by means of the angle bracket.

SPECIFICATIONS

Capacitance Range: See price list.

Plate Shape: Straight-line capacitance.

Support: A single, hard-rubber end plate supports the entire assembly.

Low Losses: $R\omega C^2$ is approximately 0.004×10^{-12} .

Maximum Voltage: 500 volts, peak.

Knob: TYPE 637-A Knob supplied.

Mounting: Bushing for single-hole panel mounting; bracket for baseboard mounting. See sketch.

Dimensions: See sketch and price list.

Net Weight: Approximately 3 ounces, all sizes.

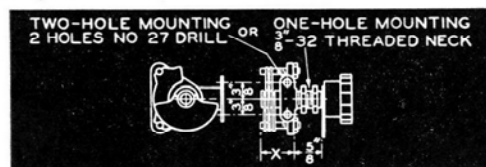

Type	Capacitance		Depth (X)	Code Word	Price
	Max.	Min.			
368-A	15 $\mu\mu\text{f}$	4 $\mu\mu\text{f}$	1 $\frac{3}{8}$ in.	BULLY	\$0.75
368-B	50 $\mu\mu\text{f}$	4 $\mu\mu\text{f}$	1 $\frac{1}{2}$ in.	BURIN	1.00
368-C	100 $\mu\mu\text{f}$	4 $\mu\mu\text{f}$	2 in.	AZURE	1.50

TYPE 756-A VARIABLE AIR CONDENSER

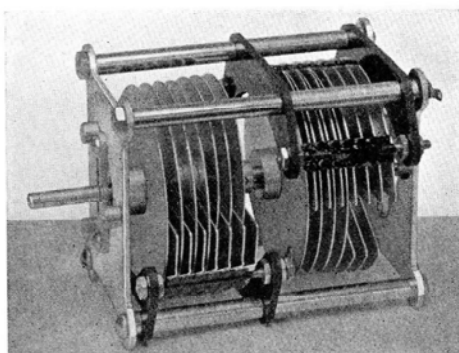

TYPE 756-A

This condenser is a double-section, band-spread type for use in circuits where two band-spread variable capacitances are required. Four of the seven rotor plates are complete circles. The position of several is adjustable along the shaft to give any desired spread.

SPECIFICATIONS

Capacitance Range: See price list.

Plate Shape: Approximately straight-line frequency; 180° dial required.

Direction of Rotation: Counter-clockwise for increasing frequency.

Supports: Two small sections of first-quality hard rubber support the stator.

Low Losses: $R\omega C^2$ is approximately 0.07×10^{-12} .

Maximum Voltage: 1500 volts, peak.

Mounting: Identical with TYPE 334 Condensers described previously.

Dimensions: Same as TYPE 334 Condensers described previously. Dimension A, 5 inches.

Net Weight: 2 pounds.

Type	Capacitance per Section		Code Word	Price
	Maximum	Minimum		
756-A	225 $\mu\mu\text{f}$	140 $\mu\mu\text{f}$	METAL	\$6.00

TYPE 380 DECADE CONDENSER UNIT

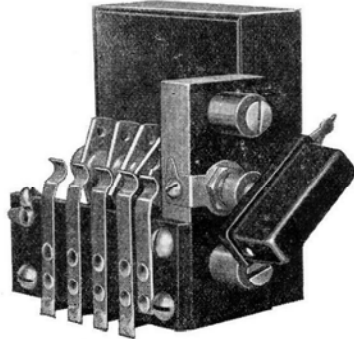

The TYPE 380 Decade Condenser Unit is an assembly of individual paper or mica con-

densers and a selector switch arranged so that any one of 10 decade values may be chosen. It is made in three individual decade series, each with 10 steps of 0.001 μf , 0.01 μf , or 0.1 μf , respectively.

The excellence of these units is due, in large measure, to care in manufacture and aging. All mica is carefully selected and units built of them are moulded in bakelite. Paper condensers are thoroughly impregnated with molten paraffin during winding. Succeeding layers of the conducting foil make contact, thus avoiding the increase in power factor with frequency which occurs when only the ends of the winding are connected.

SPECIFICATIONS

Capacitance: Three sizes are available with decade steps of 0.001 μf , 0.01 μf , and 0.1 μf per step. See the price list. The desired value of capacitance is secured by various combinations of four condensers having values of 1, 2, 3, and 4, respectively.

Dielectric: Mica is used for the two smaller sizes and paraffin paper for the largest one.

Maximum Voltage: The maximum peak alternating-current voltage should never be allowed to exceed the rated direct-current voltage, *i.e.*, 300 volts. The losses in any condenser with the solid dielectric are a function of the applied frequency and it is necessary to consider frequency when placing a maximum voltage limit, since excessive heat can cause temperature increases that are disastrous in a calibrated unit. The peak voltage may be kept at the 300-volt maximum for frequencies below 1000 kc for the 0.001- μf decade, below 100 kc for the 0.01- μf decade, and below 1 kc for the 0.1- μf decade. At higher frequencies the voltage should be reduced in direct proportion to the increase in frequency.

Power Factor: $R\omega C$, the power factor, is 0.002, 0.001, and 0.010 for the 0.001- μf , 0.01- μf , and 0.1- μf units, respectively.

Calibration: The shaft of each unit is provided with a detent device to make definite the position

of the switch for each setting. After allowance has been made for a "zero capacitance" of 40 μmf (due to the switch and to wiring) the units will be found to be accurate to within 2% for the 0.1- μf and 0.01- μf decade units, and to within 5% for the 0.001- μf decade unit.

Knob: TYPE 202-Z supplied.

Mounting: Individual decades are mounted in brass cans with a bakelite panel.

Dimensions: Panel space, height, 3 $\frac{3}{4}$ inches; width A is shown in price list. Each unit will extend 3 $\frac{7}{8}$ inches behind the back face of the panel on which it is mounted.

Net Weight: Approximately 1 $\frac{3}{4}$ pounds, all sizes.

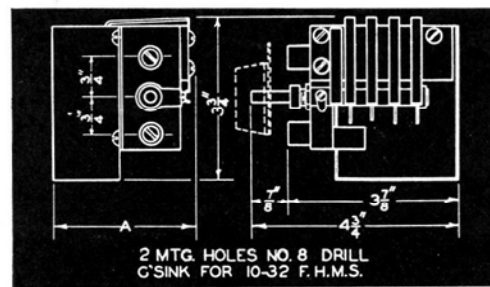

Type	Capacitance	Width (A)	Code Word	Price
380-A	1.0 μf total, in steps of 0.1 μf	3 $\frac{5}{8}$ in.	ADAGE	\$10.00
380-B	0.10 μf total, in steps of 0.01 μf	3 $\frac{5}{8}$ in.	ADDER	12.00
380-C	0.010 μf total, in steps of 0.001 μf	3 $\frac{1}{8}$ in.	ADDLE	10.00

TYPE 505 CONDENSER

This is a small, handy, mica condenser having low losses and excellent stability of calibration. It is temperature compensated and its price is low.

The General Radio Company has felt for some time that there is need for a well-designed condenser falling in the

quality scale between accurately adjusted primary standards on the one hand and the inexpensive moulded types on the other.

India mica was chosen as the dielectric because of its excellent characteristics and a mounting method was developed that makes capacitance practically independent of temperature and power factor of humidity.

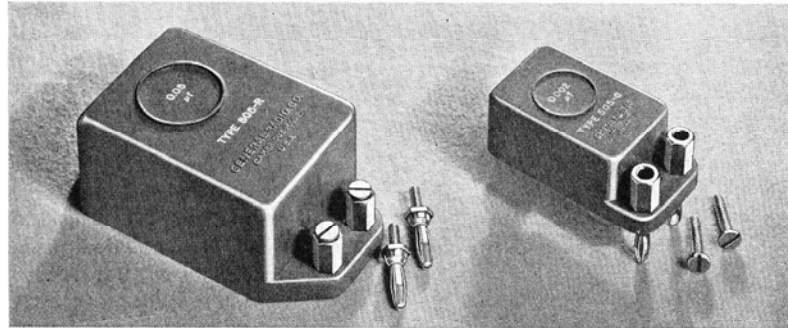

All models have both screw-type and plug-type terminals.
Left, large case; right, small case

Every piece of mica is carefully inspected for mechanical defects and other imperfections which cause large dielectric losses. It is because of this that TYPE 505 Condensers have their remarkably low phase angles. Losses are further reduced by the use of yellow low-loss bakelite ("XN-262 Natural" of the Bakelite Corporation) for the case.

SPECIFICATIONS

Capacitance: Sizes are available in stock as shown in the price list. (Other sizes can be built to order, prices on request.)

Accuracy of Adjustment: See price list.

Temperature Coefficient: Less than 0.006% per degree C. between 0° and 50° C.

Maximum Voltage: See price list. This rating means that the condenser will safely withstand the a-c voltage whose peak equals the given rating up to the given frequency. Above that frequency, the

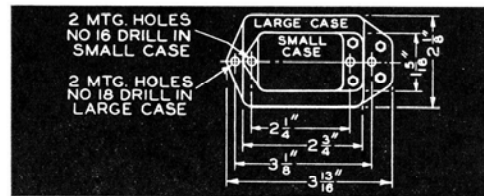

allowable voltage decreases inversely with the square root of the frequency because of the power loss.

Power Factor: Less than 0.05% for frequencies below 2 Mc, except for the three small sizes. Special precautions are taken in assembling and sealing the condensers to insure against change in capacitance or power factor due to varying moisture content of the air, and to aging. The chart shows the value of the equivalent series resistance in ohms that would have to be placed in series with a perfect condenser to give the real power loss of a TYPE 505 400- $\mu\mu\text{f}$ Condenser.

Terminals: Screw terminals spaced $\frac{3}{4}$ inch apart. Two TYPE 274-P Plugs are supplied with each condenser so that it may be converted to plug-terminal model.

Mounting: Low-loss (yellow) bakelite cases in two sizes as shown in the sketch. TYPES 505-R, 505-T, 505-U, and 505-X take the large case.

Dimensions: See sketch.

Net Weight: 4 ounces for small, 12 ounces for large size.

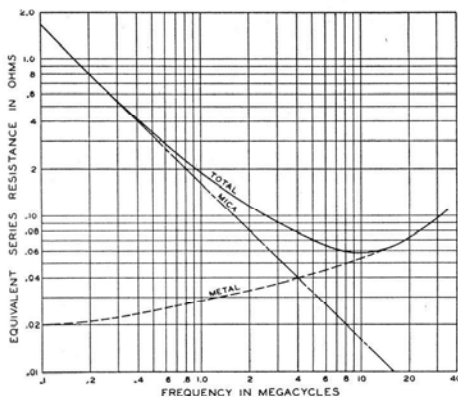

Equivalent-resistance-versus-frequency characteristic of a typical TYPE 505 Condenser

Type	Capacitance	Adjusted to		Maximum Voltage		Code Word	Price
		Within	Power Factor	Voltage at Frequency	Frequency		
505-A	100 $\mu\mu\text{f}$	10%	0.1 %	1200 v	2200 kc	CONDENALLY	\$3.50
505-B	200 $\mu\mu\text{f}$	5%	0.1 %	1200 v	1100 kc	CONDENBELL	3.50
505-E	500 $\mu\mu\text{f}$	2%	0.08 %	1200 v	880 kc	CONDENCOAT	3.50
505-F	0.001 μf	1%	0.05 %	1200 v	440 kc	CONDENDRAM	3.50
505-G	0.002 μf	1%	0.05 %	700 v	640 kc	CONDENEYRE	3.50
505-K	0.005 μf	1%	0.05 %	700 v	260 kc	CONDENFACT	4.00
505-L	0.01 μf	1%	0.05 %	700 v	130 kc	CONDENGIRL	4.50
505-M	0.02 μf	1%	0.05 %	700 v	65 kc	CONDENHEAD	5.50
*505-R	0.05 μf	1%	0.05 %	700 v	60 kc	CONDENCALM	6.50
*505-T	0.1 μf	1%	0.05 %	700 v	30 kc	CONDENCROW	7.50
*505-U	0.2 μf	1%	0.05 %	700 v	16 kc	CONDENWIPE	12.00
*505-X	0.5 μf	1%	0.05 %	500 v	12 kc	CONDENWILT	20.00

*Mounted in large case.

TYPE 492-A OXIDE RECTIFIER

One kind of junction of copper oxide has the property of unilateral conductivity. The TYPE 492-A Oxide Rectifier consists of four copper-oxide rectifier units arranged in the form of a bridge, thus providing full-wave rectification of an applied alternating voltage. The rectifier is useful for operating relays and for measuring alternating voltages by means of d-c instruments.

The unit is offered in its present form for experimental purposes and it must be realized in this connection that changes in both sensitivity and frequency response with output load and impressed voltage are to be expected. Fixed resistors can be inserted in series or in shunt with the rectifier unit to reduce these

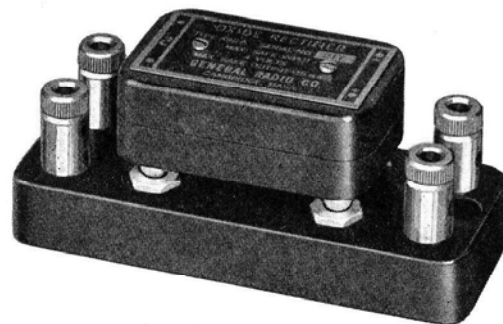

A TYPE 492-A Oxide Rectifier and a TYPE 274-RJ Mounting Base

apparent variations. TYPE 500 Resistors are recommended.

SPECIFICATIONS

Frequency Error: The rectifier may be used without appreciable frequency error at frequencies below 5000 cycles per second.

Temperature Error: Temperature errors of about 5% may be expected between normal extreme temperatures. Maximum sensitivity is obtained with a load of 5000 to 7000 ohms. This value should be used when the instrument is operating a relay. If a 1-milliamper meter of 400- or 500-ohms resistance is used, full-scale deflection will be obtained at about 2 volts across the rectifier input.

The maximum current output from the rectifier should not exceed 15 ma, nor should the impressed voltage exceed 3 volts.

Obviously, the apparent change of impedance with resistance can be greatly reduced by proper use of series and shunt resistance on the input side.

Mounting: As illustrated. Plugs fit TYPE 274-RJ Mounting Base (which is not supplied).

Dimensions: (Length) $2\frac{1}{8}$ x (breadth) $1\frac{3}{8}$ x (depth) $\frac{3}{4}$ inches, exclusive of plugs.

Net Weight: 2 ounces.

Type	Code Word	Price
492-A	FLORA	\$7.00

TYPE 493 VACUUM THERMOCOUPLE

The vacuum thermocouple presents a convenient means for measuring high-frequency current. It consists of a junction of two dissimilar metals which, when heated, sets up a direct voltage capable of actuating a d-c indicating meter.

This type of instrument is a true integrating ammeter since the d-c meter reading is a function of the r-m-s current in the heater circuit. For this reason a thermocouple and meter give results that are independent of waveform, and frequency errors can occur only at frequencies so high that the stray capacitances in the couple mounting become significant (beyond 20 Mc). The couple may be calibrated on direct current.

Both the contact type and the separate-heater type are available. In the contact type the heater circuit is in electrical contact with the couple circuit. In the separate-heater type the heating element is separated from the couple junction by a small bead of glass, thus electrically insulating the two circuits while providing good thermal contact.

The contact-type couples are easier to build and consequently less expensive, and yet our method of building the separate-heater models

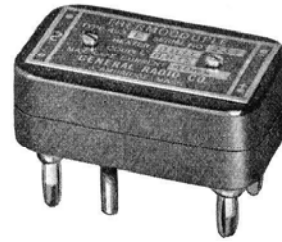

TYPE 493 Thermocouples are mounted in a bakelite case with plugs to fit a TYPE 274-RJ Mounting Base

has been so greatly improved that a comparable degree of sensitivity is obtained. Separate-heater couples can, of course, be used at high frequencies with fewer precautions against the effects of stray capacitances to ground.

Thermo-junctions are mounted in an evacuated glass bulb. The vacuum reduces heat conduction from the couple as well as the effect of external temperature variations. The glass bulb is surrounded by felt and mounted in the bakelite container shown in the illustration, ready for mounting in a TYPE 274-RJ Mounting Base.

SPECIFICATIONS

Type of Couple: The type number "493" is used to designate all thermocouples described here. Contact-type thermocouples are indicated by means of a single letter which also designates the heater current, *e.g.*, 493-A. The letter "H" is used to indicate a separate-heater type of couple, *e.g.*, 493-HA.

Couple Resistance: The resistance of all couples is adjusted to between 10 and 12 ohms, the value engraved on each nameplate being accurate to 0.1 ohm of the actual couple resistance. This is a significant specification since the user can select a meter of the proper resistance and sensitivity to give full-scale deflection without overloading the thermoelement by considering the couple to be a generator of internal resistance equal to the couple resistance and developing an open-circuit voltage of 10 millivolts when the heater current is that given in the table on the next page.

Heater Resistance: Heaters are adjusted to within $\pm 10\%$ of the values given in the table. The actual value engraved on the nameplate is given to within 0.01 ohm for TYPES 493-A, 493-C, 493-HA, and 493-HC; to within 0.1 ohm for TYPES 493-E and

493-HE; and to within 1 ohm for TYPES 493-H, 493-K, 493-HH, and 493-HK.

Electrical Sensitivity: The price list gives the heater current required to produce 10 millivolts across the couple terminals on open circuit. This value is held to within $\pm 10\%$.

Thermal Sensitivity: 26 microvolts per degree Fahrenheit.

Overload: All heaters will withstand a continuous overload of 50% of the current given in price list.

Coefficient of Resistance: Couple elements, 0.00013 per degree Fahrenheit; heater 0.00009 per degree Fahrenheit.

Meter: TYPE 588-AM Direct-Current Meter is recommended for use with these couples.

Mounting: Mounted in bakelite case, as illustrated, with plugs to fit TYPE 274 Mounting Bases having four jacks. The TYPE 274-RJ Mounting Base is recommended.

Dimensions: (Length) $2\frac{1}{8}$ x (breadth) $1\frac{3}{8}$ x (depth) $\frac{3}{4}$ inches, exclusive of plugs.

Net Weight: 2 ounces.

CONTACT-TYPE COUPLES

Type	Heater Resistance	Current to Give 10 Millivolts Open Circuit	Code Word	Price
493-A	0.5 Ω	275 ma	FUNNY	\$12.00
493-C	2 Ω	100 ma	FOCUS	12.00
493-E	10 Ω	25 ma	FOLLY	12.00
493-H	100 Ω	8 ma	FORAY	12.00
493-K	450 Ω	4.5 ma	FORUM	12.00

SEPARATE-HEATER TYPE COUPLES

Type	Heater Resistance	Current to Give 10 Millivolts Open Circuit	Code Word	Price
493-HA	0.5 Ω	275 ma	EAGER	\$15.00
493-HC	2 Ω	100 ma	EDICT	15.00
493-HE	10 Ω	25 ma	EARLY	15.00
493-HH	100 Ω	8 ma	EASEL	15.00
493-HK	450 Ω	4.5 ma	EDIFY	15.00

TYPE 588-AM DIRECT-CURRENT METER

This is a direct-current galvanometer having full-scale sensitivity of 500 microamperes and a resistance of 10.0 ohms (5 millivolts) which adapts it for use in conjunction with TYPE 493 Thermocouples. Since each thermocouple must be individually calibrated, the scale is laid out with 50 equal divisions marked from 0 to 50, thus making easy the preparation and reading of calibration curves. The meter is supplied with the TYPE 298-B Meter Mounting which has jacks for plugging in the thermocouple.

The input terminals are set on the General Radio standard 3/4-inch spacing to take all double plugs of the TYPE 274 series.



A TYPE 588-AM Direct-Current Meter showing how a TYPE 493 Thermocouple or a TYPE 492-A Oxide Rectifier can be plugged in

This meter may also be used with the TYPE 492-A Oxide Rectifier, described previously.

SPECIFICATIONS

Range: 0 to 500 microamperes full scale.

Resistance: Approximately 10 ohms.

Scale: The 2 1/2-inch scale is divided into 50 equal divisions marked 0 to 50.

Calibration: Full-scale deflection is adjusted to within 2% of the specified value of 500 microamperes. Other points are not calibrated, but de-

flection is approximately proportional to current over the entire range.

Adjustment: A screw is provided in the glass face for making the zero adjustment.

Dimensions: (Length) 5 7/8 x (width) 3 13/16 x (height) 2 7/8 inches.

Net Weight: 1 1/8 pounds.

Type	Range	Code Word	Price
588-AM	0-500 microamperes	OURMETMUSH	\$26.00

**TYPE 572-B
MICROPHONE HUMMER**

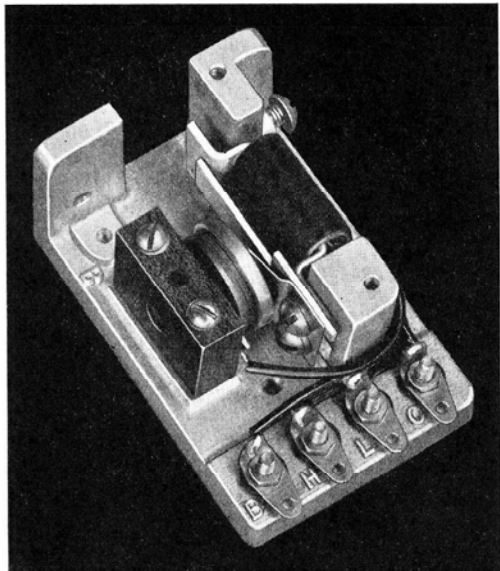

This is an electro-mechanical oscillator in which the frequency is determined by a tuned reed. It is intended for use as a low-power, a-c source for bridge and other measurements where extreme purity of waveform and frequency stability are not essential.

SPECIFICATIONS

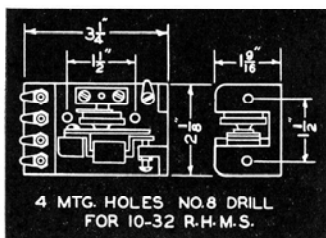

Frequency: 1000 cycles $\pm 10\%$.
Output: 20 milliwatts, maximum.
Internal Output Impedance: 10 or 300 ohms.
Power Supply: This oscillator is designed to operate from a $4\frac{1}{2}$ -volt battery, Burgess No. 2370, or equivalent.
Mounting: Supplied unmounted as illustrated.
Dimensions: (Length) $3\frac{1}{4}$ x (width) $2\frac{1}{8}$ x (height) $1\frac{1}{8}$ inches, over-all.
Net Weight: 9 ounces.

Type	Code Word	Price
572-B	APHIS	\$10.00

TYPE 358 WAVEMETER

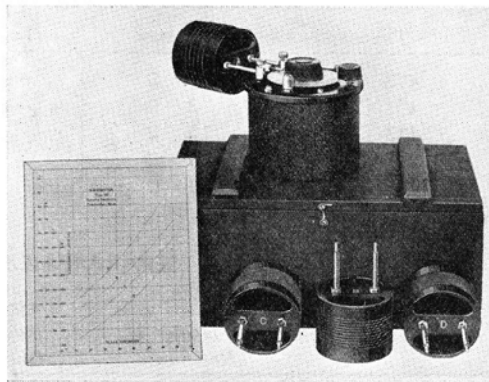

The TYPE 358 Wavemeter is a compact, general-purpose instrument of moderate accuracy covering a wide frequency range and it is particularly well adapted to general-purpose checking work around the laboratory. The normal wavelength range of 15 to 220 meters (20,000 kc to 1364 kc) can be extended to 1200 meters (250 kc) by ordering the two additional coils mentioned in the price list.

SPECIFICATIONS

Range: 15 to 220 meters (20,000 kc to 1364 kc). By ordering the two extra inductors* mentioned in the price list, the range can be extended to 1200 meters (250 kc).

Accuracy of Calibration: 1%. Calibrated in wavelength.

Condenser: TYPE 247 Condenser with slow-motion pinion-gear drive in drawn-steel case.

Inductors: Four, on bakelite forms, fitted with pins to fit condenser terminals.

Resonance Indicator: Small flashlight bulb in special socket which closes circuit on removal of bulb.

Carrying Case: Space provided in wooden case for four inductors, condenser, and calibration chart.

Dimensions: Carrying case, (length) $11\frac{3}{4}$ x (width) 7 x (height) $5\frac{3}{4}$ inches, over-all.

Net Weight: $4\frac{1}{2}$ pounds.

Type	Frequency Range	Code Word	Price
358	15 m to 220 m	UPPER	\$17.50
	Additional inductors for extending range to 1200 m	*COILY	12.00

*Use compound code word UPPERCOILY when wavemeter with extra inductors is wanted.

TYPE 535-A FREQUENCY METER-MONITOR

This instrument combines a monitor and an accurate heterodyne-frequency meter for use in all the amateur bands including 56 Mc. It is calibrated at 13 points in the 1715-kc to 2000-kc band, harmonics being used for the higher frequencies. A voltage-stabilized electron-coupled Colpitts oscillator is used to insure the best possible frequency stability. The mechanical construction is the same high quality as that used in General Radio laboratory apparatus.



TYPE 535-A Frequency Meter-Monitor

The 6-inch precision dial allows setting to be made to within 1 part in 1500.

SPECIFICATIONS

Frequency Range: 1700 kc to 2000 kc and all harmonics of this range up to at least the 32nd, equivalent to 54.4 Mc to 69 Mc.

Calibration: Each instrument is calibrated at 13 points against a primary standard of frequency. Calibrations can be readily checked against ARRL standard-frequency transmissions or against broadcast stations.

Frequency Stability: Excellent. Bulletin No. 315-B, giving information in detail, will be mailed on request.

Condenser: Two-section, band-spread type.

Resonance Indicator: Phones can be plugged into the standard telephone jack on the panel.

Dimensions: (Length) 11 x (height) 7½ x (width) 8½ inches, over-all.

Net Weight: 11 pounds.

Type	Frequency Range	Code Word	Price
535-A	All amateur bands	MERRY	\$42.50

PATENT NOTICE. Licensed under patents of the American Telephone and Telegraph Company solely for utilization in research investigation, measurement, testing, instruction, and development work in pure and applied science. Also licensed under Patent No. 1,943,302.

TYPE 560-A CRYSTAL HOLDER

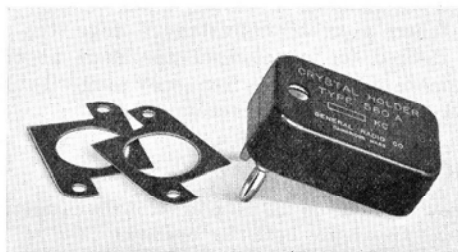

TYPE 560-A Crystal Holder

This is a pressure-type quartz-crystal holder primarily designed for operation with crystals in the amateur bands. It has a dust- and

moisture-proof bakelite case with the spring pressure on the top plate adjustable. Any amateur crystal up to 1⅛ inches square can be used. Electrodes are of chromium-plated brass, tarnish and corrosion proof. Three blank bakelite retention plates which may be cut to fit the crystal used are provided. The spacing between the two terminal plugs is General Radio standard ¼ inch.

Net Weight: 4 ounces.

Type	Code Word	Price
560-A	ABAF	\$2.25

AUDIO-FREQUENCY TRANSFORMERS

In this section is described a complete line of high-quality audio-frequency transformers, including models designed for vacuum-tube-input, vacuum-tube-interstage, vacuum-tube-output, impedance-matching, and circuit-isolation uses.

These transformers have lap-jointed laminated cores of the best grade of silicon steel, the use of which results in the unusually good frequency characteristics that are obtained. By reason of the high current that can be tolerated before saturation occurs, parallel plate feed does not have to be used under normal operating conditions. The transformers are unaffected by mechanical shock, are shielded against electrostatic fields, and, because of thorough 1000-volt insulation, they are proof against breakdown under transient surge peaks. They may be used in permanent installations with the knowledge that they will retain their characteristics through years of use.

To preserve the symmetry of push-pull tapped windings so that subsequent stages

may be truly balanced, the coils of the vacuum-tube-interstage transformers are built up in alternate primary and balanced secondary layers. This construction increases the coupling coefficient of the transformer and decreases the distributed capacitance of both windings, therefore extending the upper-frequency limit without introducing high-frequency resonance peaks on open circuit (interstage) operation.

For use in high-fidelity circuits with unbalanced stages, the light additional loadings recommended in the tables will preserve the frequency characteristics to well within the limits stated. All ratings are conservative and represent the performance that may be expected under the most unpromising conditions.

Experimenters and development engineers will find in these transformers reliable units having negligible insertion losses when they are properly terminated. They may be used without fear of distortion in the many communication, amplifier, line, bridge, balanced, and unbalanced circuits encountered in engineering work.

VACUUM-TUBE-INPUT AND -INTERSTAGE TRANSFORMERS

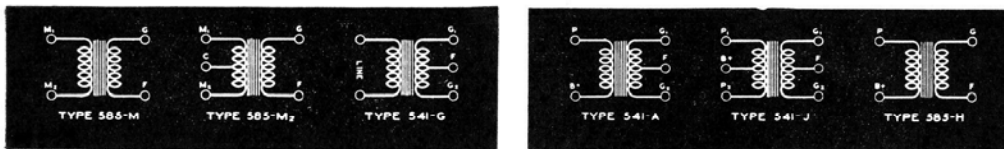

INPUT TYPES

Carbon microphones, pickups, and mixer sources of from 50 ohms to 400 ohms internal impedance may be matched to a grid through the use of the TYPE 585-M or TYPE 585-M₂ Transformers diagramed above.

Reflectionless line termination for lines between 400 and 600 ohms and coupling to either balanced or unbalanced amplifiers may be obtained with the TYPE 541-G Transformer which is designed especially for this service.

INTERSTAGE TYPES

For the intermediate stages the TYPE 541-J Transformer will meet all possible arrangements of either single-tube or push-pull connections. It will work from sources ranging from 1000 to 5000 ohms in impedance by using half the primary winding.

Where a greater interstage voltage step-up is desired for unbalanced amplifiers at the expense of a narrowed frequency range, TYPES 541-A and 585-H are recommended.

SPECIFICATIONS

Use: The most common uses of the transformers are suggested in the second column of the following table. Values of source impedance and primary direct current have been chosen for tubes that are most frequently encountered in practice.

Frequency Range: The table gives the frequency range over which the voltage ratio is less than 2 db

below its value on the flat portion of the characteristic. This range holds for operation "Out of" a source having the impedance shown in column three and into the grid or grids of the succeeding stage. For values of source impedance between those tabulated, the frequency range may be found by direct interpolation.

The "Pri. DC" column gives the normal primary current for the transformer when working out of a single tube or the permissible current unbalance when working out of tubes in push-pull. The specified frequency range will be obtained with this value of current. The low-frequency limit is decreased by approximately 25% when no direct current flows. The effect on the frequency characteristic of a 100% increase in "Pri. DC" is negligible at frequencies greater than 80 cycles.

Turns Ratio: The ratio of turns of the whole primary winding to the whole secondary winding is given in the "Turns Ratio" column of the table.

Primary Winding: The 60-cycle inductance of the whole primary as measured with the tabulated value of "Pri. DC" flowing, is given in the "L" column. The maximum value of current that may be applied to any part of the primary is stated in the "I Max." column.

Mounting: Each transformer is mounted in a standard drawn-steel, wax-filled Model B case, illustrated on the next page.

Dimensions: See dimensioned drawing, Model B case.

Net Weight: All types, 3 pounds.

Type	Use	Frequency Range (Down 2 db) ¹				Turns ¹ Ratio	Primary		Code Word	Price
		Out of (ohms)	Pri. DC (ma)	From (cycles)	To (cycles)		L ¹ (h)	I Max. (ma)		
541-J	P-P Plates to P-P Grids	20,000 ³ 10,000	0.25 ² 0.4 ²	30 25	10,000 13,000		150 140			
	One Plate ⁴ to P-P Grids	16,000 10,000	2.5 5	30 35	11,000 13,000	1 to 2.1	75 65	15	ABHOR	\$7.50
	One Plate ⁴ to One Grid ⁴	16,000 ⁵ 10,000 ⁶ 5000	2.5 5 8	30 35 28	11,000 11,000 12,000		75 65 55			
541-A	One Plate to P-P Grids	10,000 5000	5 8	60 40	8000 12,000	1 to 3.0	35 30	15	TALLY	6.00
585-H	One Plate to One Grid	10,000	5	50	7000	1 to 3.2	40	15	TIPSY	6.00
541-G	Line or Mixer ⁸ to P-P Grids	400-600 ⁷	—	30	13,000	1 to 9.7	8	30	ABEAM	10.00
	Line or Mixer ⁸ to One Grid ⁴	400-600 ⁹	—	30	13,000					
585-M2	Single- or Double-Button Microphone to Single Grid	400 200 ¹	5 ² 20	40 40	7000 7500	1 to 13.8	3 2	80	TARRY	6.00
585-M	Single-Button Microphone to Single Grid	200 50	20	45 40	7000 8000	1 to 27.8	0.7	100	TARDY	6.00

¹ Data are for whole of tapped windings.

² Dc for 10% unbalance in push-pull connection.

³ Connect 250,000Ω across each half of secondary.

⁴ Use whole winding, P₁ or G₁ to plate or grid.

⁵ Connect 75,000Ω between G₂ and F.

⁶ Connect 100,000Ω between G₂ and F.

⁷ Connect 100,000Ω across each half of secondary. Without resistors response is up 2 db at 11,000 cycles.

⁸ To reflect exactly 500Ω to primary, connect 25,000Ω across each half of secondary; for single-grid use, high-frequency limit is then 10,000 cycles.

⁹ Connect 35,000Ω between G₂ and F.

SPECIAL TRANSFORMERS

The General Radio Company has had wide experience in the custom design and production of transformers to meet requirements not covered by stock models. Among these types are transformers with extra and monitoring windings, transformers to operate in mixer circuits of unusual impedance, and to simulate the characteristic of the human ear. Special

transformers for the tripping of control circuits as well as transformers for inclusion in recording seismographs and other scientific research instruments can also be supplied.

Prices will be quoted on inquiry. Please state desired frequency characteristic and the values of generator and load impedances between which the transformer is to work.

VACUUM-TUBE OUTPUT TRANSFORMERS

An output transformer may be selected from the four shown below to couple a vacuum tube to all but the most unusual values of line or speaker impedances. For a large number of these special cases designs are already on hand with the result that these types may be furnished without undue expense or delay.

Type 541-C

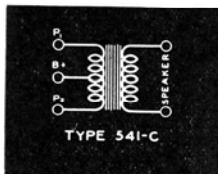

The TYPE 541-C Transformer is available for output uses where it is desired to couple a push-pull, 4000- to 12,000-ohm output stage to the voice coils of one or more dynamic speakers. With multiple loads the optimum impedance ratio of 1300 to 1 should govern the choice of arrangement of secondary connections.

This is the transformer recommended for use with tubes of the following types: 10, 31, 45, 46 (Class A), 49 (Class A), 59 (Class A), 71-A, 89 (Class A), and 112-A.

Type 541-D

The TYPE 541-D Transformer is a universal output transformer for use with two 2A3 tubes in a balanced (push-pull) stage, although use of generator impedances between 700 and 2000 ohms will cause no appreciable change in the frequency characteristic.

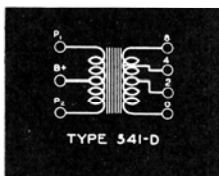

The choice of a secondary tap and the arrangement of the speaker connections should be such as to load correctly the output stage. The load presented to the tubes will be the transformer load multiplied by the square of

the turns ratio of the transformer for the particular secondary tap used. In particular, the correct load for the 2A3 tubes varies, depending on whether fixed bias or self-bias is used. The table shows the best connections.

Load Impedance		Terminals to Which Load is Connected
(Self-Bias)	(Fixed Bias)	
1.5- 3 ohms	1- 2 ohms	0-2
3 - 5.7 ohms	2- 4 ohms	0-4
5.7-12 ohms	4-10 ohms	0-8

Type 541-P

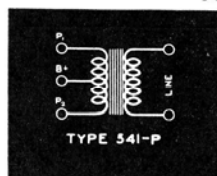

TYPE 541-P Transformer will feed lines of from 400 to 600 ohms impedance from a push-pull stage of output tubes. Its excellent characteristic allows it to be used

indiscriminately to interconnect high-fidelity systems with no loss in the over-all frequency range. This transformer is also recommended for feeding any balanced or unbalanced amplifier output into a line-impedance-level mixer system, or for use in the output stage of a microphone pre-amplifier.

Type 541-B

TYPE 541-B is a speaker-coupling device making use of the greater efficiency of auto-transformers to drive a magnetic speaker or other 4000- to 10,000-ohm load from balanced or unbalanced output stages. Blocking condensers are included in the case to keep the high plate potential off the output terminals and direct current out of the load.

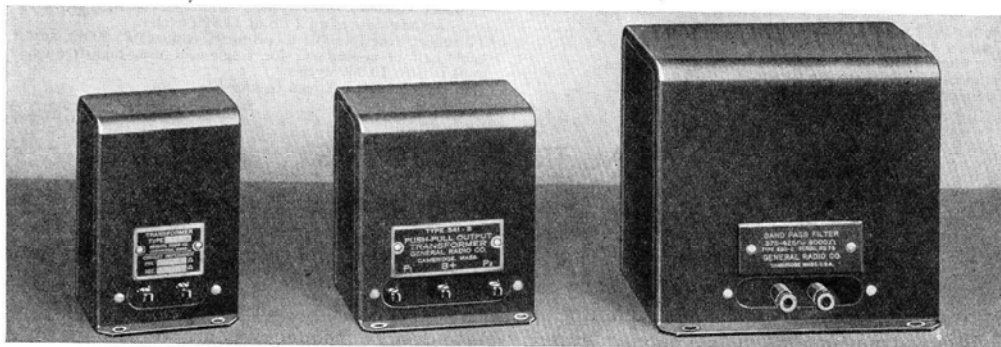
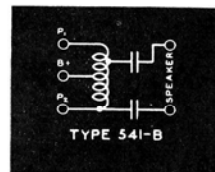

MODEL B

MODEL C

MODEL D

General Radio transformers are mounted in the three sizes of cases shown by the samples above

SPECIFICATIONS

Use: The most common uses of the transformers are suggested in the second column of the following table. Values of source and load impedances and primary direct current have been chosen for conditions that will most frequently be met in practice.

Frequency Range: The table gives the frequency range over which the voltage ratio is less than 2 db below its value on the flat-top portion of the characteristic. This range holds for operation "Out of" a source having the impedance shown in column three and "Into" a load of value shown in column four. For values of source and load impedances between those tabulated, the frequency range may be found by direct interpolation.

The "Pri. DC" column gives the normal primary current for the transformer when working out of a single tube or the permissible current unbalance with push-pull input circuits. The specified frequency range will be obtained with this value of current. The low-frequency limit is decreased by approximately 25% when no direct current flows.

Turns Ratio: The ratio of turns of the whole primary winding to the whole secondary winding is given in the "Turns Ratio" column of the table.

Primary Winding: The 60-cycle inductance of the whole primary as measured with the tabulated value of "Pri. DC" flowing, is given in the "L" column of the table. The maximum value of current that may be applied to any part of the primary is stated in the "I Max." column.

Mounting: Each transformer is mounted in a standard drawn-steel, wax-filled Model B case except TYPE 541-B, which is mounted in a Model C case. Both are illustrated on the opposite page.

Dimensions: See the dimensioned drawing, this page, Models B and C cases.

Net Weight: TYPE 541-B, 4 pounds; all other types, 3 pounds.

Type	Use	Frequency Range (Down 2 db) ¹					Primary				Price
		Out of (ohms)	Into (ohms)	Pri. DC (ma) ²	From (cycles)	To (cycles)	Turns Ratio	L ¹ (h)	I Max. (ma)	Code Word	
541-C	P-P Plates to Voice Coil	10,000	4-15	1	30	12,000	35.6 to 1	45	50	TAPER	\$6.00
		4000	4-15	3	25	10,000					
541-D	P-P Plates to Voice Coil	4000	4-16 ³	3	40	15,000	23.6 (33.3) ³ (47.2) ³ to 1	12	70	TULIP	6.00
		2000	1-12 ³	3	30	15,000					
541-P	P-P Plates to Line or Mixer	32,000	400-600	0.13	15	18,000	4.4 to 1	75	25	ABIDE	6.00
		20,000	400-600	0.25	25	16,000		70			
		10,000	400-600	0.4	20	12,000		65			
	One ⁴ Plate to Line, Mixer	16,000	400-600	2.5	30	16,000	1	30			
		10,000	400-600	5.0	30	16,000		27			
541-B	P-P Plates to Magnetic Speaker	10,000	4000-10,000	1	30	8500	1.4 to 1	45	50	TORSO	10.00
		4000	4000	3	35	8000		25			

¹ Data are for whole of tapped windings.

² Dc for 10% unbalance, when push-pull connection is used.

³ Using taps on windings.

⁴ Use whole winding, P1 to plate.

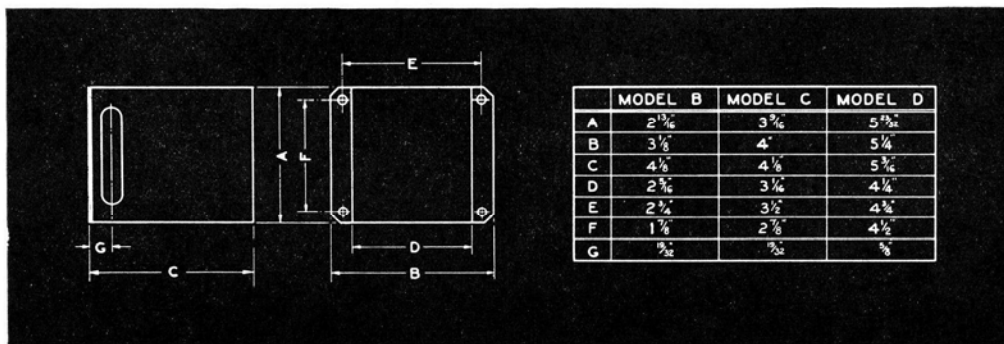

Dimensions for standard General Radio transformer-mounting cases

IMPEDANCE-MATCHING TRANSFORMERS

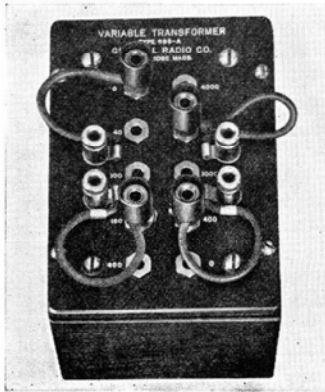

TYPE 666-A

They may be used in either direction, that is, as step-up or step-down impedance-matching transformers. The frequency ranges given in the tables hold for this use of the transformers as well, and the "Pri. DC" limit still holds. If the "secondary" winding is connected to the source and the frequency range is to be maintained, the number of aiding d-c milliampereturns for the whole transformer must not exceed the value it has under rated conditions.

Type 585-R

The TYPE 585-R Transformer is a high-quality, unity-ratio, circuit isolator for use between transmission lines of from 500 to 700 ohms impedance. The primary and secondary windings are thoroughly shielded from each other to minimize electrostatic coupling with the result that on balanced lines the parallel component of interference energy is filtered from the signal. The provision of center-tapped windings allows interchangeable use between balanced and unbalanced systems and also for their interconnection.

In bridge measurements the use of this transformer makes the bridge balance independent of electrical or locational changes in the detector circuit, assuring greater accuracy and ease of balance.

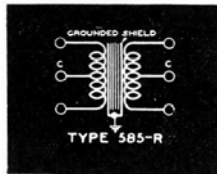

TYPE 585-R

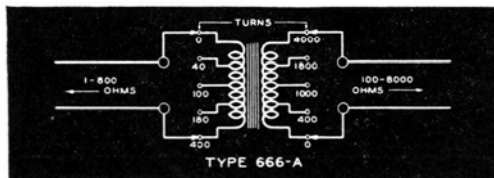

TYPE 666-A

Type 585-C

For line-interconnection and mixer problems the TYPE 585-C Transformer presents the facilities of an impedance changing device with impedance transformation ratios of 1 to 10, 1 to 2.5, 1 to 1.56, 1 to 0.64, 1 to 0.25, and 1 to 0.10, allowing the transformations shown in the table to be taken in either direction. The desired ratios are obtained as shown in the diagrams at the foot of the opposite page. The terminals are so arranged that only adjacent ones need be strapped.

LABORATORY TRANSFORMERS

The following two transformers are not to be used for impedance matching in quality communication or program circuits. They are valuable in alternating-current measurements not dependent on relative response at widely separated frequencies.

Type 666-A

Where it is desired to have the impedance ratio easily adjustable over a wide range by means of a plug arrangement at the expense of attenuation of the high and low frequencies, the TYPE 666-A Variable Transformer is recommended. Primarily a laboratory instrument, this transformer is provided with jack-top binding posts to receive a TYPE 274 Plug and has multi-tapped windings with the included turns from one end marked plainly on the panel. Any portions of the windings may be used; not only is the impedance ratio adjustable but approximate ratios may be obtained through different arrangements, allowing a choice of a favorable value of primary inductance.

Type 166

For use in a-c bridge circuits with telephone detectors, where the frequency characteristic is subordinate to the requirement of a detector of the correct impedance for maximum sensitivity, the TYPE 166 Telephone Transformer should be employed.

The various connections are made directly to binding posts mounted on the terminal plate of the instrument.

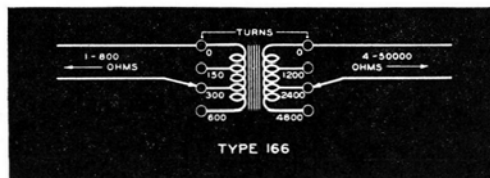

TYPE 166

SPECIFICATIONS

Use: The most common uses of the impedance-matching transformers are suggested in the second column of the following table. The associated data are chosen for conditions that will most frequently be met in the suggested uses.

Frequency Range: The table gives the frequency range over which the voltage ratio is less than 2 db below its value on the flat portion of the characteristic. This range holds for operation "Out of" a source and "Into" a load having the impedances shown in columns three and four. For intermediate values of source and load impedances the frequency range may be found by direct interpolation.

Turns Ratio: The turns ratio of the whole primary winding to the whole of the secondary winding is given in the "Turns Ratio" column of the table. For the adjustable-ratio transformers, TYPES 666-A and 166, the turns included between the tap and one end are shown in the individual diagrams at the foot of the opposite page.

Primary Winding (Higher Impedance Winding): The nominal 60-cycle inductance of the whole pri-

mary is given in the "L" column of table. The maximum current that may be applied to any part of the windings is stated under "I Max."

Mounting: TYPES 585-C and 585-R are mounted in standard drawn-steel, wax-filled Model B cases.

For TYPES 666-A and 166 see illustrations.

Dimensions: For TYPES 585-C and 585-R see dimensioned drawing, Model B case. TYPE 666-A: 3 1/2 x 4 1/2 x 5 in.; TYPE 166: 2 1/4 x 2 3/4 x 3 1/2 in.

Net Weight: TYPES 585-C and 585-R, 3 pounds; TYPE 666-A, 3 1/2 pounds; TYPE 166, 1 1/2 pounds.



TYPE 166

Type	Use	Frequency Range (Down 2 db) ¹				Turns ¹ Ratio	Fig.	Primary		Code Word	Price
		Out of (ohms)	Into (ohms)	From (cycles)	To (cycles)			L ¹ (h)	I Max. (ma)		
585-C	Line, Mixer to	400-600	150-250	25	10,000	1.6	A	6	50 (pri.)	ABODE	\$6.00
		400-600	40-60	25	11,000	(3.2) ²	B		100 (sec.)		
	Line, Mixer	100-150	150-250	25	11,000	(0.8) ²	C		to 1		
		100-150	40-60	25	12,000		D				
585-R	Line, Mixer to	800	800	30	16,000	1		3	75 (pri. & sec.)	ABOMA	6.00
		400	400	25	18,000	1					
166	Bridge to Detector	4-50,000 ²	1-800 ²			1 to 8			9 (pri.) 90 (sec.)	TOPIC	6.00
666-A	General Purpose Matching	100-8000 ²	1-800 ²			1 to 10			60 (pri.) 150 (sec.)	ABOON	12.50

¹ Data are for whole of split or tapped windings.

² Using taps on windings.

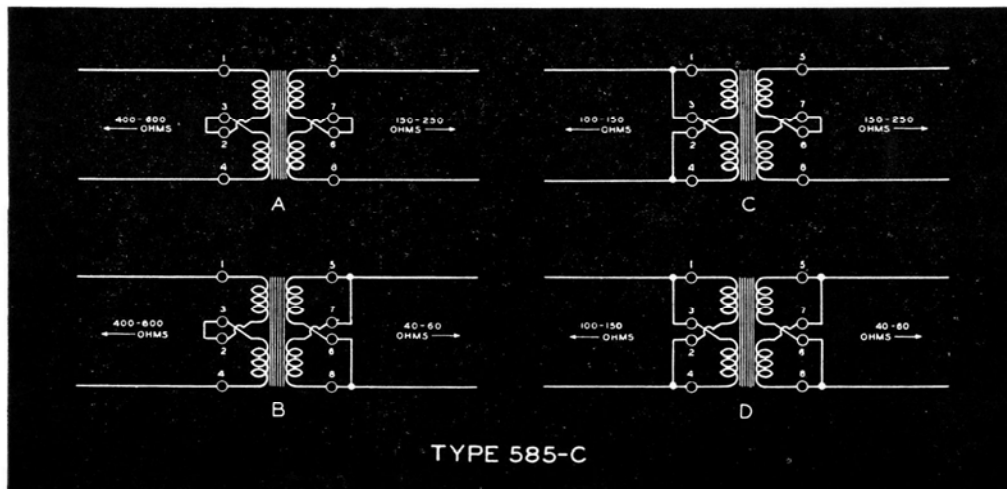

TYPE 585-C

TYPE 480 RELAY RACK

This rack is intended for mounting standard 19-inch panels whose heights are integral multiples of $1\frac{3}{4}$ inches. Racks of this type have been in use in telephone plants for many years, and they are fast becoming standard in laboratories for mounting apparatus. Two sizes are available.

Attention is also directed to the TYPE 660-A Rack described on opposite page.

SPECIFICATIONS

Construction: Steel frame with welded joints. Both models have provision for bolting them to the floor or table, but they are stable enough to stand without fastening for all ordinary service.

Drilling: Standard drilling for 19-inch relay-rack panels is employed. Holes are tapped and cleaned for a 10-32 panel-mounting screw (TYPE 738-D).

Accessories: Panel-mounting screws, panel-protecting washers, and bridle rings for cabled wiring are supplied.

Dimensions: TYPE 480-A: Frame, (height) $69\frac{1}{8}$ x (width) 20 x (depth) 3 inches, over-all. Base, (width) 20 x (depth) 15 inches. Panel-mounting space, 63 inches or 36 "rack units."

TYPE 480-B: Frame, (height) 44 x (width) 20 x (depth) $1\frac{1}{2}$ inches, over-all. Base, (width) 20 x (depth) 15 inches. Panel-mounting space, $43\frac{3}{4}$ inches or 25 "rack units."

Net Weight: TYPE 480-A, 94 pounds. TYPE 480-B, 20 pounds.

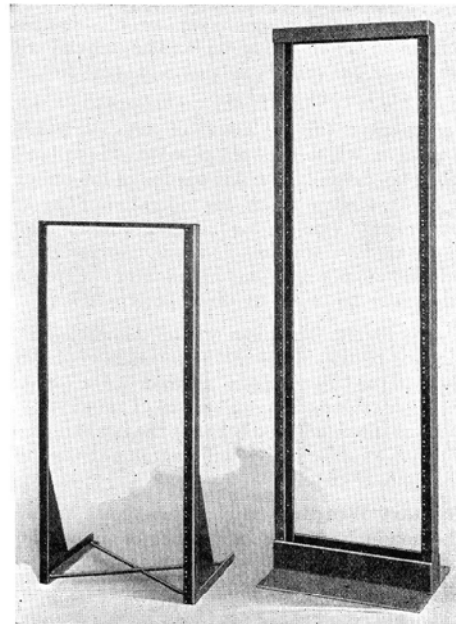

Left: TYPE 480-B; right: TYPE 480-A

Type	Panel Space		Code	Price
	Inches	Rack Units		
480-A	63	36	NEEDY	\$40.00
480-B	$43\frac{3}{4}$	25	NEGRO	15.00

NOTES ON LAYING OUT RELAY-RACK PANELS

1. Make panel height a multiple of $1\frac{3}{4}$ inches less $\frac{1}{32}$ inch for clearances.

2. Both top and bottom edges of a properly mounted panel will, neglecting clearances, always fall half way between a pair of holes spaced $\frac{1}{2}$ inch apart on the rack.

3. It is seldom necessary to cut all the possible mounting-screw slots in a panel, but it can be done if desired.

4. Any panel laid out to fit the rack will also fit if the panel is turned end-for-end or back-for-front.

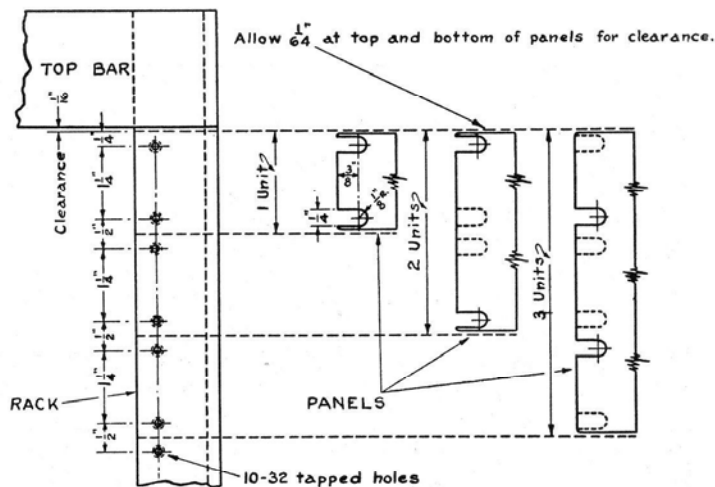

Note: Clearance between vertical supports on rack $17\frac{1}{2}$ inches.

UNIT PANELS

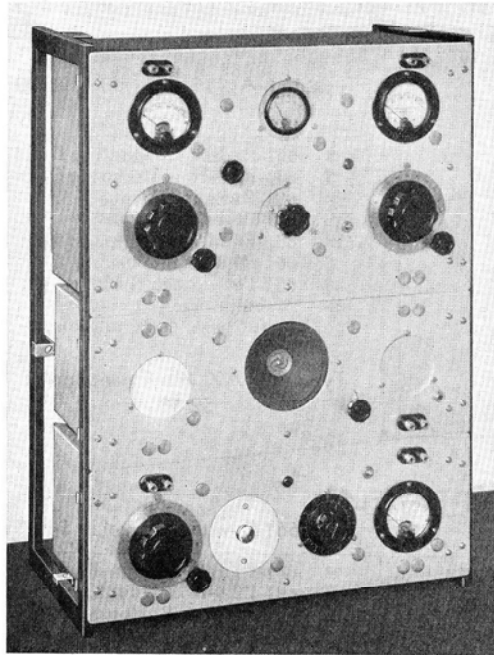

An assembly of TYPE 661 Unit Panel equipment on a TYPE 660 Rack

General Radio has recently developed a series of unit panels designed to facilitate the fabrication of experimental and semi-permanent assemblies. All parts are interchangeable. Layout changes can be made at any time without disfiguring the panel, and a unit is easily disassembled for conversion into an entirely different instrument.

The parts required for a complete metal box are a base, two end plates, a dust cover, and a panel (with the accessories accompanying it). All principal parts are made of Eraydo, a non-magnetic, non-corrosive alloy of copper, silver, and zinc, which is stronger than materials commonly used for such parts. One face is satin finished and coated with clear lacquer.

The drawings on the next page show to scale the location of all holes. Each panel has several 2 7/8-inch diameter holes symmetrically placed, around each of which are three small holes for mounting the standard bakelite (Navy type) meter case, or for fastening mounting discs to the panel. Adjacent to each large panel hole is a 1/2-inch hole for the slow-motion mechanism of a 4-inch, TYPE 703 Dial.

At both top and bottom near either end are located pairs of 1/2-inch holes on 3/4-inch centers to fit TYPE 274 Panel Insulators with TYPE 138-VD Binding Posts for input and output connections. Other holes are intended for single-hole-mounting parts such as rheostats, telephone jacks, etc. Bushings for reducing the diameter of the holes to 1/16 inch or 3/8 inch are furnished with the panel. Unused holes are plugged with TYPE 661-P4 Snap Buttons.

One panel is furnished with a 5-inch, permanent-magnet dynamic loudspeaker, the input impedance of which is 3000 ohms.

Four types of mounting discs are available. TYPE 661-P1 Blank Mounting Discs are used either to cover the large panel holes not in use, or to mount parts other than those manufactured by General Radio. The center of each is pricked on the reverse to facilitate layout.

The TYPE 661-P2 3-Hole Mounting Discs have three small holes drilled on a 7/8-inch radius for mounting General Radio parts having the standard 3-hole mounting. Short spacers which provide clearance for the disc-mounting screws are furnished. Discs can be mounted at 30° angles around 360°.

The TYPE 661-P3 Adapter Disc has a 2 1/8-inch hole and is designed to mount meters such as the Weston type 506.

Dust covers for the two sizes of end plates are available. They fit tightly and slide on from the rear so that they may be removed when the panel assemblies are mounted one above another on a relay rack.

All prices and illustrations on next two pages

TYPE 660-A UNIVERSAL RACK

This is the rack shown in the cut on this page. It consists of two rectangular steel frames which mount parallel to each other. These frames may be screwed to the bench, or they may be fastened to the bench and wall by the four clamps supplied with each rack.

TYPE 661-P5 Panel Clamps will clamp a panel to the rack in any desired position. Four

of these are supplied with each unit panel, but none are supplied with the rack. The rack can be used for panels of any width.

The height of the TYPE 660-A Rack is 26 1/2 inches (fifteen 1 3/4-inch rack units).

Type	Rack Units	Code Word	Price
660-A	15	NINNY	\$6.00

UNIT PANELS AND ACCESSORIES (Drawings 1/6th Actual Size)

19 x 12-INCH UNIT PANELS

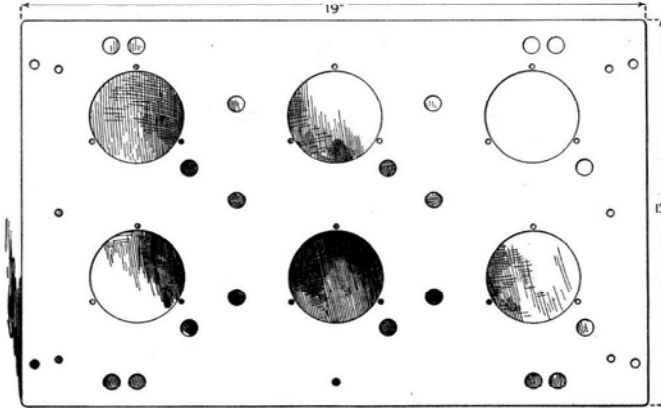

Type 661-A, with accessories, \$6.00

Number Supplied	Type	Description
3	661-P1	Blank Mounting Discs
3	661-P2	3-Hole Mounting Discs
20	661-P4	Snap Buttons
2 pr.	661-P5	Panel Clamps
12	661-P6	Mounting Spacers
6	661-P8	3/8-inch Bushing
6	661-P9	1/16-inch Bushing
25	Machine screws and nuts (for base, ends, and discs)	

Type 661-AX, blank panel only, \$2.50

19 x 7-INCH UNIT PANELS

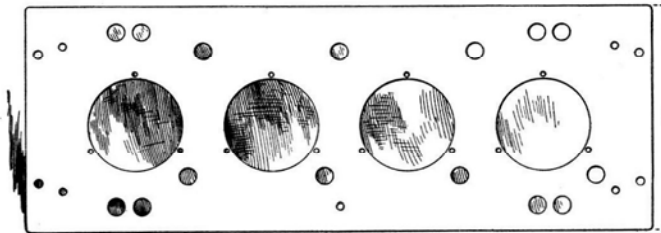

Type 661-B, with accessories, \$4.00

Number Supplied	Type	Description
2	661-P1	Blank Mounting Discs
2	661-P2	3-Hole Mounting Discs
15	661-P4	Snap Buttons
2 pr.	661-P5	Panel Clamps
9	661-P6	Mounting Spacers
4	661-P8	3/8-inch Bushing
4	661-P9	1/16-inch Bushing
17	Machine screws and nuts (for base, ends, and discs)	

Type 661-BX, blank panel only, \$1.75

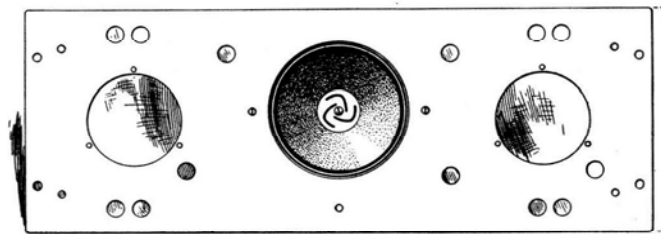

Type 661-C, with accessories, \$9.00

Number Supplied	Type	Description
1	661-P1	Blank Mounting Disc
1	661-P2	3-Hole Mounting Disc
13	661-P4	Snap Buttons
2 pr.	661-P5	Panel Clamps
6	661-P6	Mounting Spacers
4	661-P8	3/8-inch Bushing
4	661-P9	1/16-inch Bushing
13	Machine screws and nuts (for base, ends, and discs)	
1	5-inch Dynamic Speaker and Clamp	

ACCESSORIES (1/3rd Actual Size)

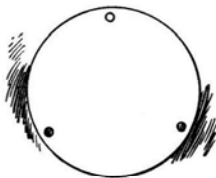

Type 661-P1
Blank Mounting Disc

For use as blank cover or "drill your own." Center prick-punched for easy layout. \$0.15 each.

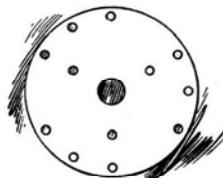

Type 661-P2
3-Hole Mounting Disc

For 3-hole mounting, 120° apart on 3/4-inch radius. 12 possible positions. \$0.20 each.

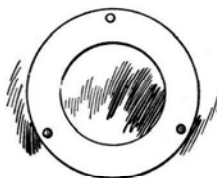

Type 661-P3
Adapter Disc

For 2 1/16-inch meters (e.g., Weston 506). \$0.20 each



Type 661-P11
Cover Plate

For use with TYPE 177-B Inductor Form and TYPE 177-K Inductor Shield. \$0.20 each

ENDS, BASES, DUST COVERS (Drawings 1/6th Actual Size)

**Type 661-K
End- and Base-Plate
Assembly**

For 19 x 12-inch Panels
\$5.00

Base plate can be mounted in any one of four positions. Machine screws and spacing pillars supplied. Order panel (shown dotted) and dust cover separately.

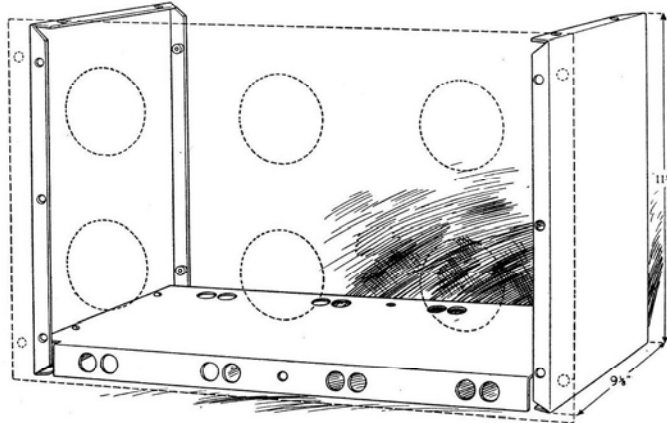

**Type 661-L
End- and Base-Plate
Assembly**

For 19 x 7-inch Panels
\$4.00

Base plate can be mounted in any one of four positions. Machine screws and spacing pillars supplied. Order panel (shown dotted) and dust cover separately.

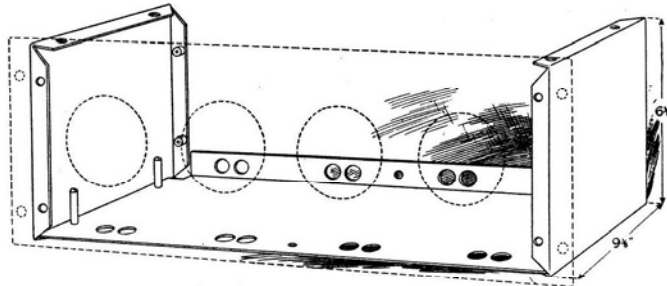

**Type 661-R Dust Cover
For 12-inch Panels
\$2.00**

**Type 661-S Dust Cover
For 7-inch Panels
\$1.50**

Fit closely. Can be attached and removed when panels are mounted one above another on a rack. Machine screws for back supplied.

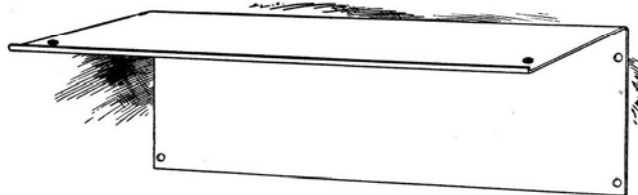

ACCESSORIES (Shown Actual Size)

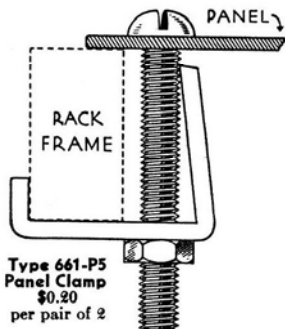

**Type 661-P5
Panel Clamp
\$0.20
per pair of 2**



**Type 661-P8
3/8-in. Bushing
Fits 1/2-in. holes
4 for \$0.10**



**Type 661-P9
7/16-in. Bushing
Fits 1/2-in. holes
4 for \$0.10**



**Type 661-P4
Snap Button
Fits 1/2-in. holes
2 for \$0.05**



**Type 661-P6
Mounting Spacers
Provide clearance for parts interfering with disc-mounting screws
6 for \$0.10**

**Type 661-P7
Dial Indicator
For G. R. dial. Supplied free with each dial when order specifically requests it. \$0.25.**

PLUG-IN INDUCTORS FOR UNIT PANELS

The three basic components shown below, together with a TYPE 661-P11 Cover Plate can be assembled in three ways to make up an effective shielded plug-in inductor for use in high-frequency experimental work. The TYPE 177-B Inductor Form can be used alone or, if desired, a TYPE 177-K Inductor Shield can be attached to make one integral unit. Then, when a shielded inductor is required for use with unit-panel assemblies, the cover plate is added, as shown in the photograph below. The shield base is securely locked to the shield top by the three bayonet catches. In the center is a threaded rod which engages a threaded insert in the TYPE 661-P10 Jack Base and draws the cover plate firmly against the panel.

The TYPE 661-P10 Jack Base can be used behind the panel or mounted horizontally on a shelf using short spacer studs.

An important feature in short-wave work is the excellent noise-free contact provided by the use of spring-type plugs and jacks. The eight sets of contacts are adequate for the most elaborate circuit. Both plugs and jacks can be removed if fewer contacts are needed. Complete assembly instructions are supplied.

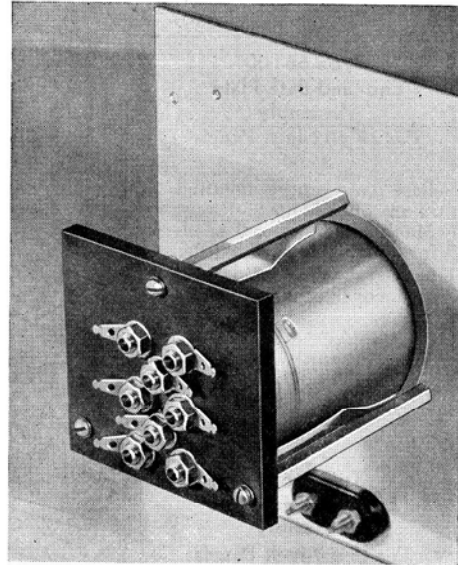

The complete shielded inductor mounts in this manner on a unit panel. The three springs on the TYPE 661-P10 Jack Base guide the inductor into place.

Type 177-K Inductor Shield

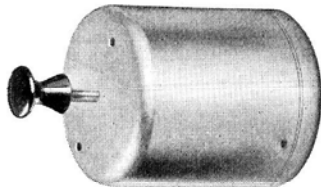

Aluminum. Fastens to TYPE 177-B Inductor Form with two machine screws supplied. The knob, clamping rod, etc., are included together

with complete assembly instructions.

Code Word: INDUCTKEMP

Price: \$0.75

Type 177-B Inductor Form

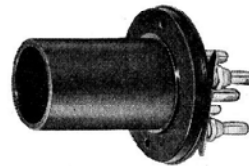

Can be used alone, with shield, or with shield and cover plate for unit-panel mounting. See photographs. Supplied with eight removable plugs (with lock-washers and lugs). Winding form: 1 1/4 inches (diameter), 1 3/4 inches (length). Moulded bakelite.

Code Word: INDUCTBOAT

Price: \$0.85

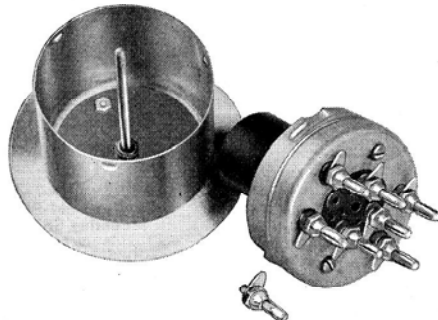

A shielded inductor-form assembly, made up from a TYPE 177-B Inductor Form, a TYPE 177-K Inductor Shield, and a TYPE 661-P11 Cover Plate

Type 661-P10 Jack Base

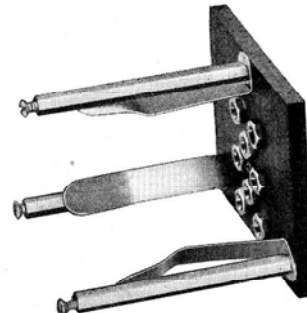

Includes eight removable jacks and lugs. Unique locating device makes plugging in coils extremely easy. Spacer bars fit unit panels. Base may, if desired, be mounted on shelf base (short spacers not included). Designed for shielded or unshielded TYPE 177-B Inductor Form.

Code Word: UNIPANBASE

Price: \$1.50

TYPE 679 INDUCTOR

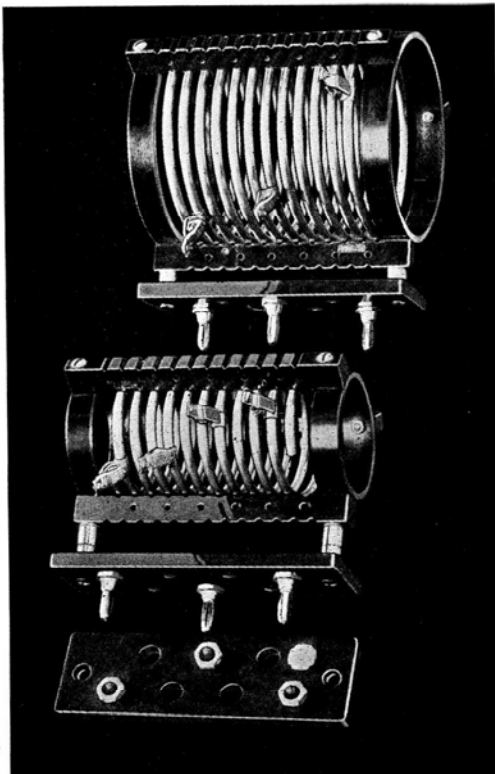

This plug-in inductor is wound with 1/4-inch, tarnish-resisting nickel-plated copper tubing, and is externally clamped by three moisture-proof glazed porcelain bars, ribbed and holed for the support and termination of external coupling windings.

Copper clips with semicircular formed jaws and three 25-ampere TYPE 674-P Plugs are provided with each inductor. As many as four additional plugs may be added as desired.

SPECIFICATIONS

	Type 679-A	Type 679-B
Turns	12	7 and 4
Number of sections	1	2
Inductance	10μh	2μh, 1.5μh
Clips supplied	3	4
Outside diameter of coil	5 3/4 in.	3 1/4 in.
Length, over-all	7 1/4 in.	7 1/4 in.
Height, over-all	8 1/2 in.	6 3/4 in.
Depth, over-all	6 1/2 in.	4 1/2 in.
Net weight	3 1/8 lbs.	2 3/8 lbs.

Type	Description	Code Word	Price
679-A	Inductor	CANAL	\$7.50
679-B	Inductor	CANDY	6.50
680-J	Base	CANOE	1.25

TYPE 677 INDUCTOR FORM

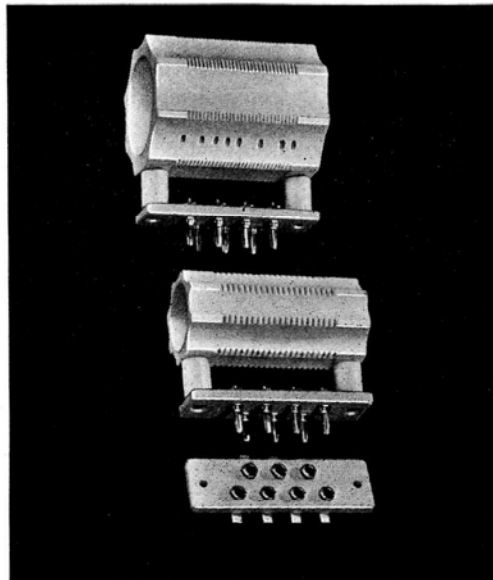

These coil forms are made of moulded porcelain in two convenient sizes. The eight notched ribs provide permanent winding spacing while the series of small holes gives adequate anchorage. Taps and separate windings up to a total of seven terminals are accommodated by a matched plug-in base and jack, separately available.

For complete assembly two TYPE 677-P1 Coil Form Spacers, with which are included the necessary machine screws, nuts and lead washers, are required. These spacers may also be used to support the jack plate.

The V-cut threads permit use of wire size up to #10 B. & S., and extend over three inches.

SPECIFICATIONS

Dimensions: Length, all units, 4 5/8 inches. Diameter, TYPE 677-U, 2 1/2 inches; TYPE 677-Y, 3 3/8 inches. Width, TYPES 678-P, 678-J, 1 1/2 inches. Height, TYPE 677-P1, 1 inch.

Net Weight: TYPE 677-U, 10 ounces. TYPE 677-P1 (per pair), 2 ounces. TYPE 677-P, 4 ounces. TYPE 677-J, 4 ounces. TYPE 677-Y, 1 5/8 pounds.

Type	Description	Code Word	Price
677-U	Coil Form	MIMIC	\$0.50
677-Y	Coil Form	MISER	.75
677-P1	Spacer (2 req'd)	MINIM	.30 (pair)
678-P	Base with 7 Plugs	MINOR	.70
678-J	Base with 7 Jacks	MINNY	.65

TYPE 577-U INDUCTOR FORM



The TYPE 577-U moulded bakelite inductor form is available to meet the need for convenient laboratory inductors. It is provided with four lugs, which may be pried loose if not required, and is drilled for TYPE 274-P Plugs and a TYPE 274-Q Locating Pin which are not supplied.

SPECIFICATIONS

Dimensions: (Diameter) $3\frac{1}{4}$ x (height) $2\frac{1}{4}$ inches.
Mounting: Holes are provided in the web to take 4 TYPE 274-P Plugs and a locating pin (not furnished). Drilled to fit TYPE 274-CJ or 274-EJ Mounting Bases.
Net Weight: 3 ounces.

Type	Code Word	Price
577-U	NATAL	\$0.70

TYPE 520-A DIAL LOCK



Any General Radio dial may be firmly clamped in any position by means of the TYPE 520-A Dial Lock which holds the edge of the dial in a vise-like grip, without exerting appreciable force on the shaft on which the dial is mounted. The lock does not alter the dial setting and may be unclamped by loosening the knurled knob when it is desired to change dial to a new setting.

SPECIFICATIONS

Dimensions: (Length) 2 x (width) 1 x (height) $1\frac{1}{2}$ inches over-all. Height above panel, 1 inch.
Mounting: Two No. 28 holes, $\frac{3}{8}$ inch apart, are required for mounting.
Net Weight: $1\frac{1}{2}$ ounces.

Type	Code Word	Price
520-A	ABATE	\$0.75

TYPE 269 VARIOMETER

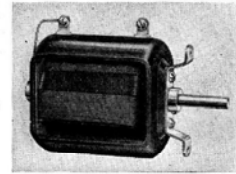

This unit is intended for use as a variable inductor, but it can also be used to vary the coupling between two circuits. It is readily mounted on a panel, and it offers a very satisfactory means of adjusting the total inductance in a circuit.

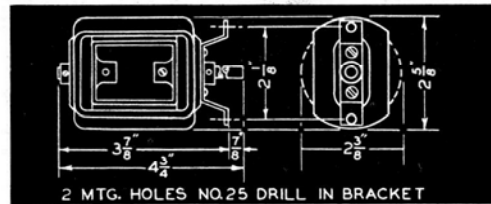

SPECIFICATIONS

Inductance: With rotor and stator connected in series the maximum inductance is approximately 820 μ h; the minimum, 100 μ h.
Shaft Diameter: $\frac{1}{4}$ inch.
Mounting: Two holes in bracket. See accompanying sketch.
Dimensions: See accompanying sketch. (Depth) $4\frac{1}{4}$ inches over-all.
Net Weight: 7 ounces.

Type	Code Word	Price
269	VALID	\$4.00

TYPE 519-A DIAL LENS

(See Illustration Opposite Page)

This consists of a small lens with an adjustable holder to mount on a panel over the dial indicator, and makes possible the reading of a dial (especially those shown on the opposite page) to a high degree of precision. When not in use the arm can be swung out of the way and the lens pushed against the panel to minimize space requirements. When in use the lens is held in proper position by a detent device.

SPECIFICATIONS

Dimensions: (Height above panel) 2 x (width) $1\frac{1}{8}$ x (length or radius) $2\frac{3}{8}$ inches.
 Focal length, $1\frac{1}{4}$ inches.
Mounting: One $\frac{3}{8}$ -inch hole required for mounting.
Net Weight: 2 ounces.

Type	Code Word	Price
519-A	ABASH	\$1.75

TYPES 704 AND 706 PRECISION DIALS

These are high-grade precision dials, with scales individually engraved on an automatic self-indexing engraving machine in fine, radial, and accurately located lines. The dial scale and the slow-motion knob rotate in the same direction.

The accuracy of the engraving and the precision of setting obtainable justify the use of a TYPE 519-A Dial Lens.

Backlash has been eliminated in the construction of these long-scale dials by setting the scale permanently and securely on the main shaft which thus has its angular position accurately indicated. The tension of the friction drive is adjustable to suit the load and the preference of the operator, and the position of the friction drive shaft may be adjusted to compensate for errors in the centering of the main shaft in the center hole by means of an eccentric bushing.

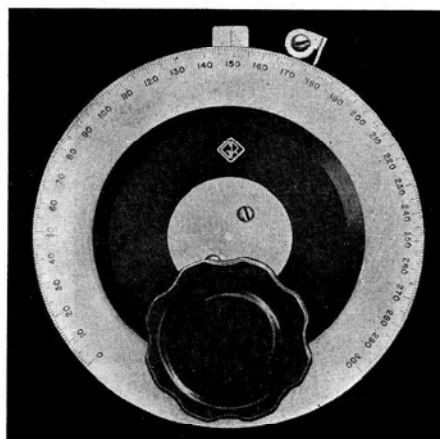

TYPE 704-D

These dials are secured to their shafts through the use of two set-screws separated by 120° and are supplied bored to receive a 3/8-inch shaft. For use with a 1/4-inch shaft, a split collar bushing is provided which securely grips the shaft throughout one inch of its length, averting all possibility of slipping.

Settings of these dials may consistently be duplicated to one-fifth of a division, allowing an accuracy of resetting, for the TYPE 706-D, of better than 0.05%. Parallax is eliminated through the use of an indicator which always remains flush with the surface of the dial, and at the same time absorbs the slight eccentricities of the main shaft through the flexibility of its mounting arm.

Only one additional hole in the panel is required for mounting; the drilling template furnished enables it to be accurately located.

The dial indicator is supplied.

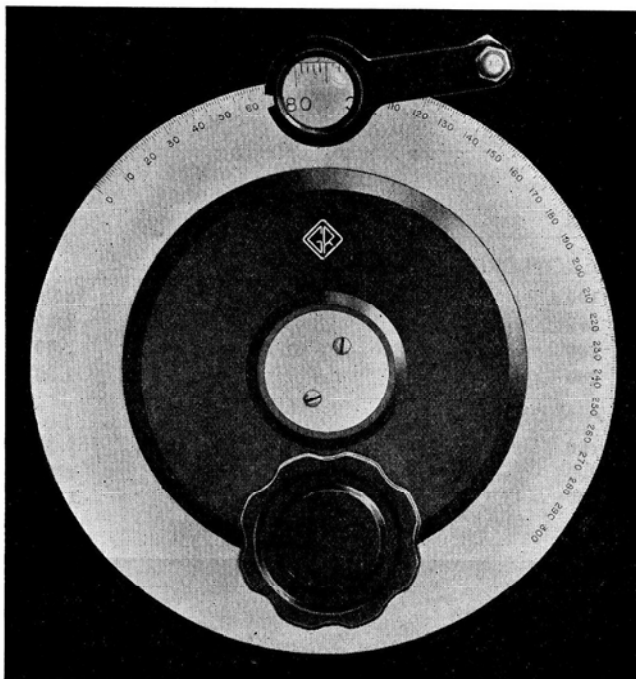

TYPE 706-C

● 4-INCH DIAMETER PRECISION DIALS

Type	Dial		Friction Drive Ratio	Net Weight	Code Word	Price
	Arc	Divisions				
704-C	180°	200	1:6	9 ounces	DABBY	\$7.50
704-D	270°	300	1:6	9 ounces	DAIRY	7.50

● 6-INCH DIAMETER PRECISION DIALS

Type	Dial		Friction Drive Ratio	Net Weight	Code Word	Price
	Arc	Divisions				
706-C	180°	300	1:8	1 pound	DASHY	\$8.00
706-D	270°	450	1:8	1 pound	DATUM	8.00

FRICION-DRIVE AND PLAIN DIALS



TYPES 702-A and 702-F

The dials described here have photo-etched, nickel-silver scales and use the fluted bakelite knob described on the opposite page.

Two diameters are available either with or without the friction drive. An indicator and drilling template are supplied.

All dials are insulated from the shaft.

See page 42 for new 3 1/4-inch dials.

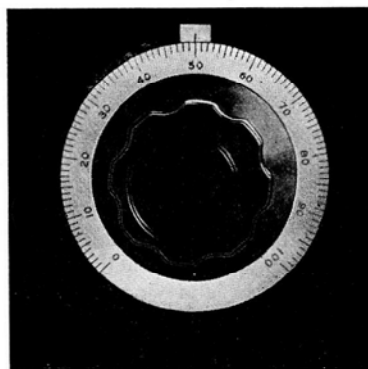

TYPES 710-B and 710-G

● 2 3/4-INCH DIAMETER — TYPE 702 FRICION-DRIVE DIALS

Type	Shaft		Dial		Friction-Drive Ratio	Net Weight	Code Word	Price
	Diameter	Arc	Divisions					
702-A	1/4 in.	180°	100		1:3.3	4 oz.	DIACK	\$1.75
702-B	1/4 in.	270°	100		1:3.3	4 oz.	DIROG	1.75
702-F	3/8 in.	180°	100		1:3.3	4 oz.	DIFAG	1.75
702-G	3/8 in.	270°	100		1:3.3	4 oz.	DIGOD	1.75

● 2 3/4-INCH DIAMETER — TYPE 710 PLAIN DIALS

710-A	1/4 in.	180°	100	2 1/2 oz.	DIALY	\$1.00
710-B	1/4 in.	270°	100	2 1/2 oz.	DIBIN	1.00
710-G	3/8 in.	270°	100	2 1/2 oz.	DIGUT	1.00

● 4-INCH DIAMETER — TYPE 703 FRICION-DRIVE DIALS

703-A	1/4 in.	180°	100		1:5	8 oz.	DIANT	\$2.00
703-B	1/4 in.	270°	200		1:5	8 oz.	DIBUT	2.00
703-F	3/8 in.	180°	100		1:5	8 oz.	DIFUN	2.00
703-G	3/8 in.	270°	200		1:5	8 oz.	DIGUM	2.00

● 4-INCH DIAMETER — TYPE 717 PLAIN DIALS

717-A	1/4 in.	180°	100	5 oz.	DIARM	\$1.50
717-B	1/4 in.	270°	200	5 oz.	DIBAR	1.50
717-F	3/8 in.	180°	100	5 oz.	DIFIT	1.50
717-G	3/8 in.	270°	200	5 oz.	DIGAR	1.50

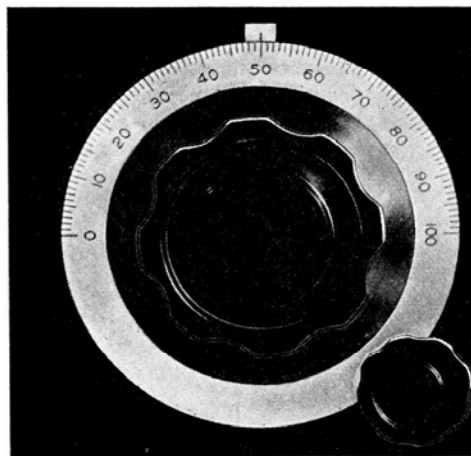

TYPES 703-A and 703-F

All illustrations 1/2 actual size

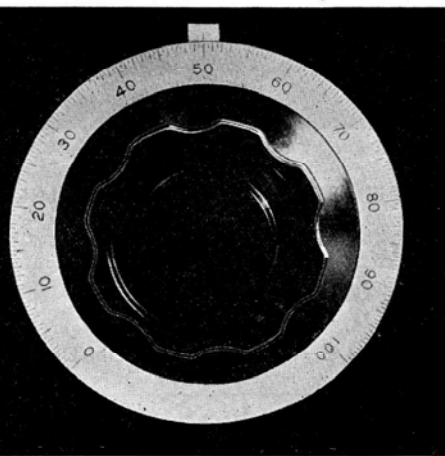

TYPES 717-B and 717-G

Friction drive licensed under U. S. Patents 1,713,146 and 1,744,675

TYPE 637 FLUTED KNOBS

The moulded bakelite knobs in this type series are now used on all new General Radio apparatus. They were chosen from among dozens of preliminary designs as the ones best suited to the requirements of measuring instruments. The smoothed fluted knurling

affords a positive, cramp-free grip for the most delicate adjustments.

The white pointers are made of non-conducting material, and they can be pried off when knobs alone are required. Each knob has two setscrews to insure permanence of setting.

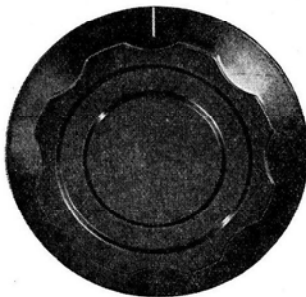
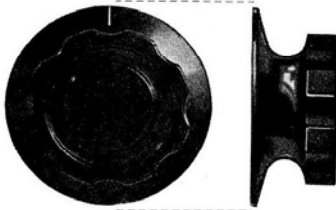

All illustrations 1/2 actual size

1 1/8-INCH DIAMETER—WITH POINTER

<i>Shaft</i>				
<i>Type</i>	<i>Diameter</i>	<i>Net Weight</i>	<i>Code Word</i>	<i>Price</i>
637-A	1/4 inch	1/2 ounce	NURLNOBANT	\$0.25
637-B	3/8 inch	1/2 ounce	NURLNOBBOY	.25

1 5/8-INCH DIAMETER—WITH POINTER

<i>Shaft</i>				
<i>Type</i>	<i>Diameter</i>	<i>Net Weight</i>	<i>Code Word</i>	<i>Price</i>
637-G	1/4 inch	1 ounce	NURLNOBGUN	\$0.35
637-H	3/8 inch	1 ounce	NURLNOBHAT	.35

1 5/8-INCH DIAMETER—WITH SKIRT

<i>Shaft</i>				
<i>Type</i>	<i>Diameter</i>	<i>Net Weight</i>	<i>Code Word</i>	<i>Price</i>
637-J	1/4 inch	2 ounces	NURLNOBJIM	\$0.40
637-K	3/8 inch	2 ounces	NURLNOBKOP	.40

(Diameter of skirt, 2 1/16 inches)

2 3/8-INCH DIAMETER—WITH POINTER

<i>Shaft</i>				
<i>Type</i>	<i>Diameter</i>	<i>Net Weight</i>	<i>Code Word</i>	<i>Price</i>
637-P	1/4 inch	3 ounces	NURLNOBPIG	\$0.40
637-Q	3/8 inch	3 ounces	NURLNOBQUO	.40

2 3/8-INCH DIAMETER—WITH SKIRT

<i>Shaft</i>				
<i>Type</i>	<i>Diameter</i>	<i>Net Weight</i>	<i>Code Word</i>	<i>Price</i>
637-R	1/4 inch	4 ounces	NURLNOBRAM	\$0.50
637-S	3/8 inch	4 ounces	NURLNOBSUM	.50

(Diameter of skirt, 3 inches)

TYPE 202 SWITCH KNOB

This is the bakelite knob that is used on our resistance boxes and decade condensers because it enables the operator to estimate the value of a setting by his sense of touch. The pointer is of nickel-plated brass. It is not insulated from the shaft.

<i>Type</i>	<i>Shaft Diam.</i>	<i>Net Weight</i>	<i>Code Word</i>	<i>Price</i>
202-Y	3/8 inch	1 ounce	SWITCHARMY	\$0.40
202-Z	1/4 inch	1 ounce	SWITCHBURG	.40

NEW 3 1/4-INCH DIALS

A new series of friction-drive and plain dials like those shown on page 40, but 3 1/4 inches in diameter, is now available. Each has 100 divisions spread over 180°. Dial insulated from shaft. Indicator and drilling template supplied.

Type	Shaft	Drive	Code Word	Price
705-A	1/4 in.	Friction	DIARK	\$1.75
705-F	3/8 in.	Friction	DIFOL	1.75
712-A	1/4 in.	Plain	DIAPE	1.25
712-F	3/8 in.	Plain	DIFAR	1.25

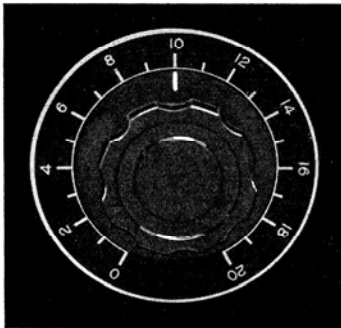

Type 318-A

A 3-inch diameter plate for use with a 1 5/8-inch knob, either pointer or skirt, and with any rheostat-potentiometer having standard 3-hole mounting. Marked with 20 divisions around 298°.

Code Word: DEVIL

Price: \$0.35

DIAL PLATES

These two dial plates have photo-etched scales with raised nickel-silver graduations on a flat black background. Each can be attached to the panel with the same screws which hold the rheostat-potentiometer with which the dial plate is used.

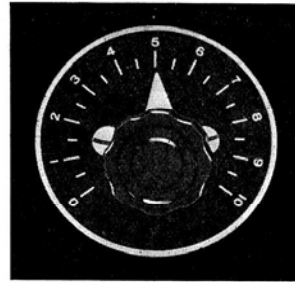

Type 522-A

A 2 1/2-inch diameter plate for use with a TYPE 637-A Knob and a TYPE 301-A or 410-A Rheostat-Potentiometer. Marked with 20 divisions around 254°.

Code Word: DOGMA

Price: \$0.35

SWITCHES

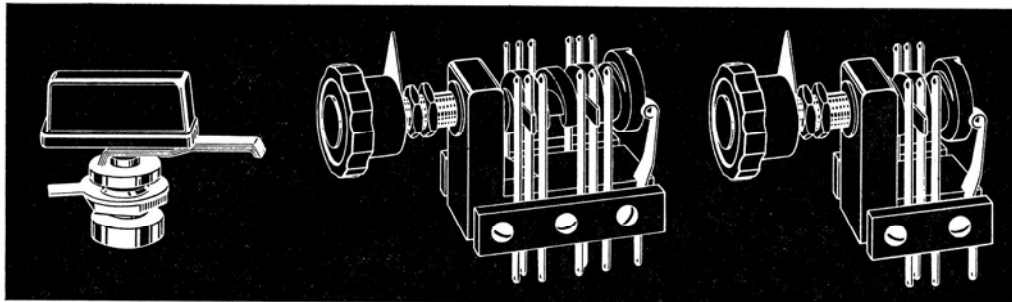

Type 202

This is a quadruple-leaf phosphor-bronze switch which makes wiping contact on both the switch points and the fixed bushing. It is intended for use with TYPE 138-B or TYPE 138-C Switch Contacts mounted on a 1 3/8-inch radius.

Type 339-A

and

Type 339-B

This is a rotary, 3-position switch for all applications where a toggle-switch-action "anti-capacity" switch would ordinarily be used. The entire throw is 180°, from one position through "off" to the third position, each position being marked by a detent device. The movable switch blades are actuated by a moulded bakelite worm.

Only one mounting hole is required for all panels up to 3/8-inch thick. Both 4-pole double-throw and 2-pole double-throw models are available. The contact springs can be bent for switching in unusual circuits.

The capacitance between switch elements is low. The switch itself is insulated for all voltages up to 250 volts, and the contacts will safely break 2 amperes.

Type	Panel Thickness	Code Word	Price	Type	Description	Code Word	Price
202-A	1/8 to 1/4 in.	SWITCHTOAD	\$0.75	339-A	4-Pole, Double Throw	PUPPY	\$2.50
202-B	1/4 to 3/8 in.	SWITCHGOOD	.75	339-B	2-Pole, Double Throw	PUTTY	2.00

SWITCH CONTACTS AND STOPS

Switch contacts are available made of nickel-plated bronze and are either with plane faces or with cupped-shaped depressions which act as detents definitely to center the switch blade in position. Each switch contact has a

knurled shoulder which, when drawn into the panel by tightening the nut, prevents rotation of the contact head.

The switch stop is made of nickel-plated brass, and is without a knurled shoulder.

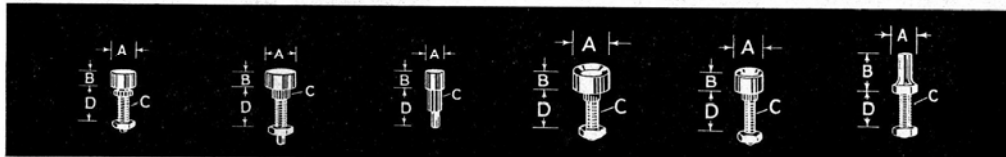

138-B 138-C 138-D 138-PD 138-CD 138-Q

Type	Description	Dimensions				Code Word	Price
		A	B	C	D		
138-B	Plane Switch Contact	1/4"	3/16"	#10 drill	3/8" max.	CONTACTANT	\$0.04
138-C	Plane Switch Contact	5/16"	3/16"	#10 drill	1/2" max.	CONTACTBUG	.04
138-D	Plane Switch Contact	3/16"	3/16"	#28 drill	1/2"	CONTACTCAT	.03
138-CD	Detent Switch Contact	5/16"	3/16"	#10 drill	1/2" max.	STANPARMUD	.05
138-PD	Detent Switch Contact	3/8"	3/16"	#10 drill	1/2" max.	STANPARNUT	.06
138-Q	Switch Stop	5/16"	7/16"	6-32 stud	3/8" max.	STANPARBUL	.04

BINDING POSTS AND ASSEMBLIES

Particular attention is directed to the three binding posts having jack tops which take plugs of the TYPE 274 series. (TYPE 138-VD, TYPE 138-V with longer stud, is not illustrated.)

The binding-post assemblies are convenient means for mounting binding posts on metal panels. The TYPE 738-A is designed for mounting, by drive fit, in a bakelite panel.

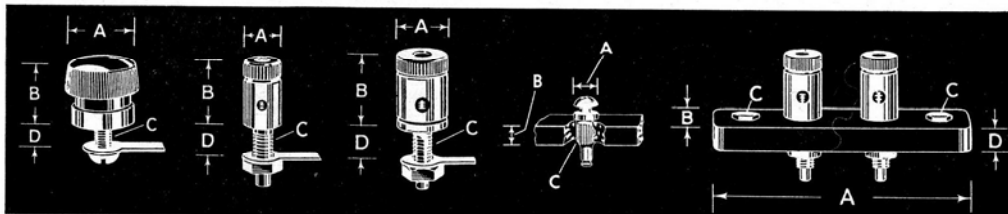

138-A 138-V 138-X 738-A 274-K

Type	Description	Dimensions				Code Word	Price
		A	B	C	D		
138-A	Binding Post (bakelite top)	3/4"	3/4" min.	10-32	3/8" max.	STANPARCUP	\$0.18
138-V	Binding Post (small jack top)	3/8"	11/16" min.	10-32	1/2" max.	STANPARANT	.20
138-VD	Binding Post (small jack top, long stud)	3/8"	11/16" min.	10-32	7/8" max.	STANPARFUN	.20
138-X	Binding Post (large jack top)	1/2"	11/16" min.	10-32	1/2" max.	STANPARBOY	.20
274-K	Assembly (with 138-V Posts)	29/16"	1"	6-32	1/4"	STANPARBAG	.65
274-L	Assembly (with 138-X Posts)	29/16"	1"	6-32	1/4"	STANPARTAG	.65
738-A	Insert Terminal	1/4"	1/4" max.	#10 drill	—	UNIPARTAPE	.04

PORCELAIN INSULATORS

These ceramic insulators are made of high-grade brown glazed porcelain and they are intended for use in wiring circuits in both inside and outside installations. Each insulator is supplied with wood screws and lead washers which will prevent breakage in mounting.

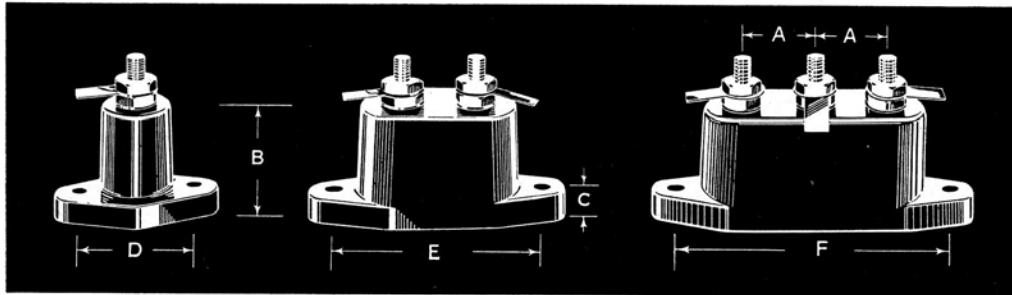

TYPE 630-A

TYPE 630-B

TYPE 630-C

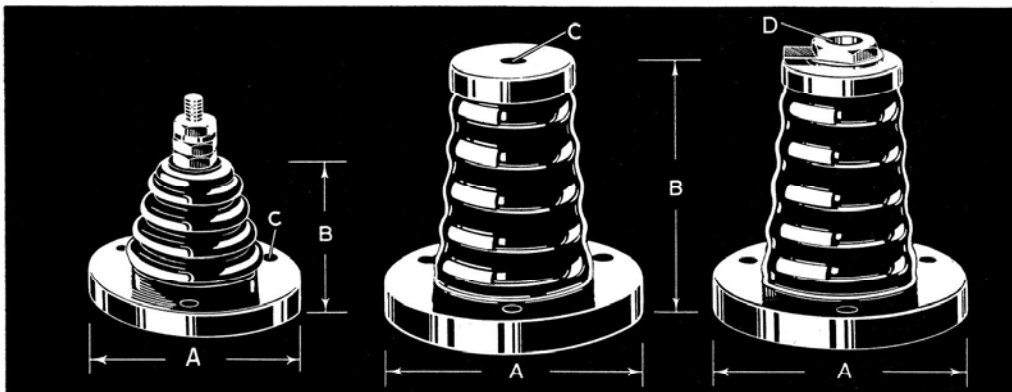

TYPE 260

TYPE 628-A

TYPE 627-A

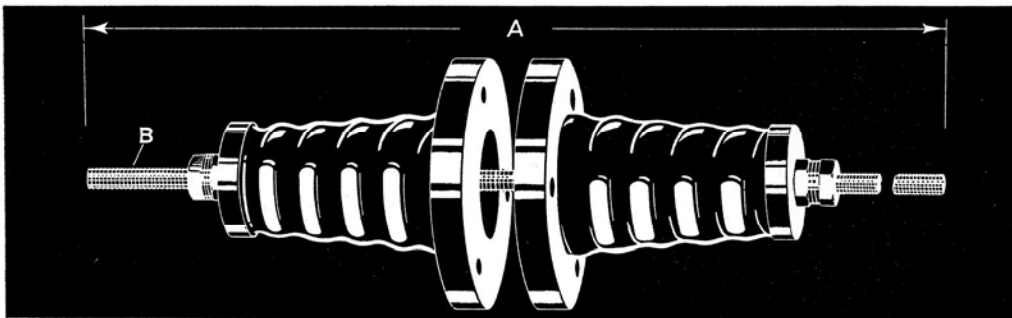

TYPE 629-A

Type	Description	Dimensions						Code Word	Price
		A	B	C	D	E	F		
260	Porcelain Insulator	2 1/16"	1 3/4"	1/8"	—	—	—	CONIC	\$0.20
627-A	Jack-Top Insulator	2 5/8"	2 3/4"	—	674-J	—	—	MAYOR	.60
628-A	Insulator	2 5/8"	2 3/4"	1/4"	—	—	—	MEDAL	.30
629-A	Lead-In Assembly	15"	1/4"	For walls up to 9" thick			—	MERCY	.90
630-A	1-Terminal Insulator	—	1 1/4"	7/8"	1 1/8"	—	—	EDUCE	.10
630-B	2-Terminal Insulator	3/4"	1 1/4"	7/8"	—	2 1/8"	—	EGRET	.20
630-C	3-Terminal Insulator	3/4"	1 1/4"	7/8"	—	—	2 7/8"	EJECT	.25

GENERAL RADIO VACUUM-TUBE SOCKETS

Here is a complete line of high-grade sockets designed particularly for use in measuring-instrument assemblies both in the "bread-board" and final model stages. Contacts are spring tempered and will make firm connection with the tube prongs even after long periods of repeated tube replacements.

Sockets are available with either bakelite or glazed isolantite bases. For most work bakelite

bases are preferable because of their lower cost, but where low high-frequency losses and high surface resistivity are essential, isolantite bases are recommended. The illustrations with the dimensions given in the price list completely describe each unit.

The net weight of all sockets is 2 ounces, except TYPES 156 and 656 which weigh 4 ounces.

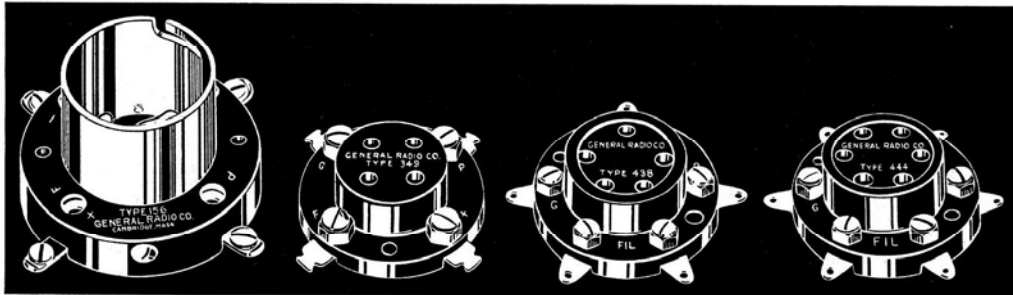

TYPE 156

TYPE 349

TYPE 438

TYPE 444

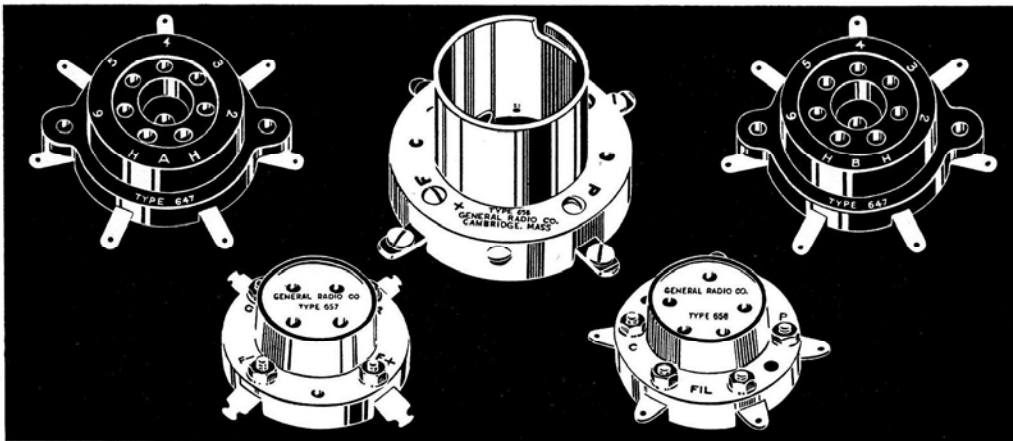

TYPE 647-A

TYPE 657

TYPE 656

TYPE 658

TYPE 647-B

Type	Base Material	Type of Tube	Base Diameter	Height	Code Word	Price
156	Bakelite	UV, UX, West. Elec. E Tube	2 ³ / ₁₆ inches	1 ¹³ / ₁₆ inches	SOBER	\$0.80
349	Bakelite	UX—Small 4-prong	1 ⁷ / ₈ inches	3/4 inch	SEDAN	.35
438	Bakelite	UY—Small 5-prong	1 ⁷ / ₈ inches	7/8 inch	STUDY	.35
444	Bakelite	Small 6-prong	1 ⁷ / ₈ inches	7/8 inch	NOVEL	.40
647-A	Bakelite	Small 7-prong	2 ⁵ / ₁₆ inches	7/8 inch	GIPSY	.40
647-B	Bakelite	Medium 7-prong	2 ⁵ / ₁₆ inches	7/8 inch	GUNNY	.40
656	Isolantite	UV, UX, West. Elec. E Tube	2 ³ / ₁₆ inches	1 ²⁷ / ₃₂ inches	SOLID	1.50
657	Isolantite	UX—4-prong	1 ⁷ / ₈ inches	1 ⁵ / ₁₆ inch	AMAZE	1.50
658	Isolantite	UY—5-prong	1 ⁷ / ₈ inches	1 ⁵ / ₁₆ inch	AMONG	1.50

PLUGS AND JACKS

The following section lists small parts which the laboratory worker and amateur will find useful in the construction of his equipment.

All multiple plugs and jacks have the General Radio standard $\frac{3}{4}$ -inch spacing between centers.

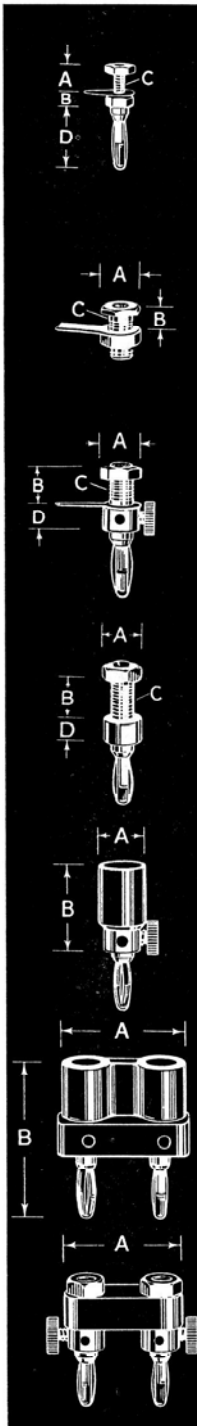

Type 274-P Plug
 Basic plug unit — Max. current, 8 a.
 $A = \frac{5}{16}$ inch max.
 $B = \frac{1}{8}$ inch
 $C = 6-32$
 $D = \frac{3}{8}$ inch
 Code Word: STANPARCAT
 Price: \$0.06

Type 274-J Jack
 Basic jack unit.
 $A = \frac{1}{16}$ inch
 $B = \frac{3}{8}$ inch max.
 $C = \frac{1}{4}$ inch—28
 Code Word: STANPARTOP
 Price: \$0.05

Type 274-E Single Plug
 As illustrated, with jack opening in stem.
 $A = \frac{1}{16}$ inch
 $B = \frac{3}{8}$ inch max.
 $C = \frac{1}{4}$ inch—28
 $D = \frac{1}{4}$ inch
 Code Word: STANPARDOG
 Price: \$0.20

Type 274-U Single Plug
 Like TYPE 274-E but without thumbscrew.
 $A = \frac{1}{16}$ inch
 $B = \frac{3}{8}$ inch max.
 $C = \frac{1}{4}$ inch—28
 $D = \frac{1}{4}$ inch
 Code Word: STANPARGOT
 Price: \$0.08

Type 274-D Insulated Plug
 Similar to TYPE 274-E but with bakelite sleeve.
 $A = \frac{1}{2}$ inch $B = 1\frac{15}{16}$ inch
 Code Word: STANPAREYE
 Price: \$0.25

Type 274-M, -ML Double Plugs
 Moulded bakelite with jacks in top and setscrews for cord tips. $\frac{3}{4}$ -inch spacing.
 $A = 1\frac{1}{4}$ inch $B = 1\frac{3}{4}$ inch
 Code Word: STANPARBUG
Type 274-M, Price: \$0.40
 Low-loss (yellow) bakelite.
 Code Word: STANPARBUY
Type 274-ML, Price: \$0.50

Type 274-G Double Plug
 Two TYPE 274-E Plugs separated by a bakelite spacer. $\frac{3}{4}$ -inch spacing. $A = 1\frac{3}{8}$ inch.
 Code Word: STANPARPIG
 Price: \$0.50

Type 674-P Jumbo Plug
 Basic jumbo-plug unit — Max. current, 25 a.
 $A = \frac{3}{4}$ inch
 $B = \frac{3}{8}$ inch
 $C = \frac{3}{8}$ inch—32
 $D = 1\frac{15}{16}$ inch
 Code Word: STANPARAPE
 Price: \$0.30

Type 674-J Jumbo Jack
 Basic jumbo-jack unit.
 $A = \frac{3}{4}$ inch
 $B = \frac{9}{16}$ inch max.
 $C = \frac{1}{2}$ inch—20
 Code Word: STANPARAYE
 Price: \$0.20

Type 674-C Jumbo Plug
 With solder-filled cup in shank for sweating-in. $\frac{1}{4}$ -inch tubing.
 $A = \frac{1}{2}$ inch $B = \frac{3}{4}$ inch
 Code Word: STANPARCOX
 Price: \$0.15

Type 674-D Insulated Jumbo Plug
 With insulated shank and soldering lug — jack in top.
 $A = \frac{3}{4}$ inch $B = 1\frac{1}{16}$ inch
 Code Word: STANPARARK
 Price: \$0.50

Type 274-BL Series Plate
 Permits connecting two circuits in series with a third having two jack-top binding posts on standard spacing.
 Code Word: STANPARSAM
 Price: \$1.25

Type 274-SB Short-Circuit Plug
 TYPE 274-U Plugs with a nickel-plated brass bar.
 Code Word: STANPARZIP
 Price: \$0.65

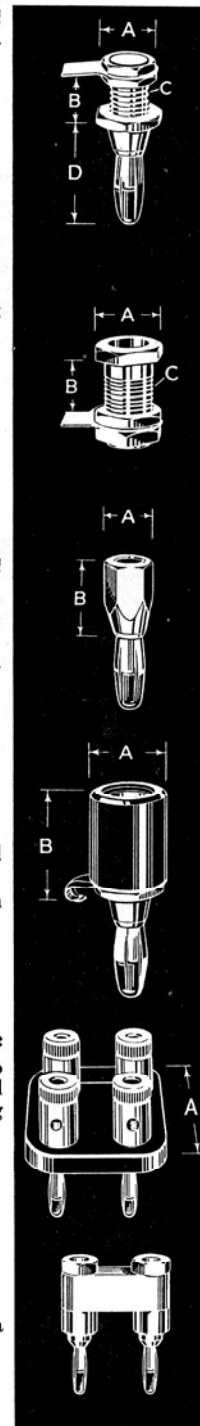

MOUNTING BASES

These units extend the possibilities of "plug in" to coils, condensers, transformers, etc.

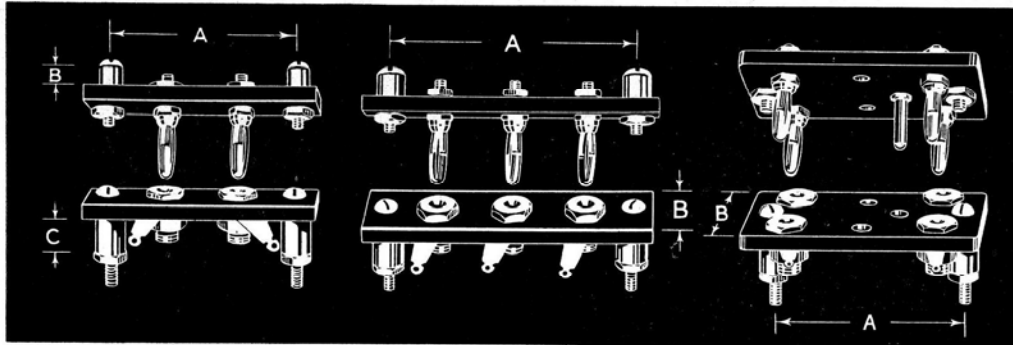

TYPE 274-AP
TYPE 274-AJ

TYPE 274-BP
TYPE 274-BJ

TYPE 274-CP
TYPE 274-CJ

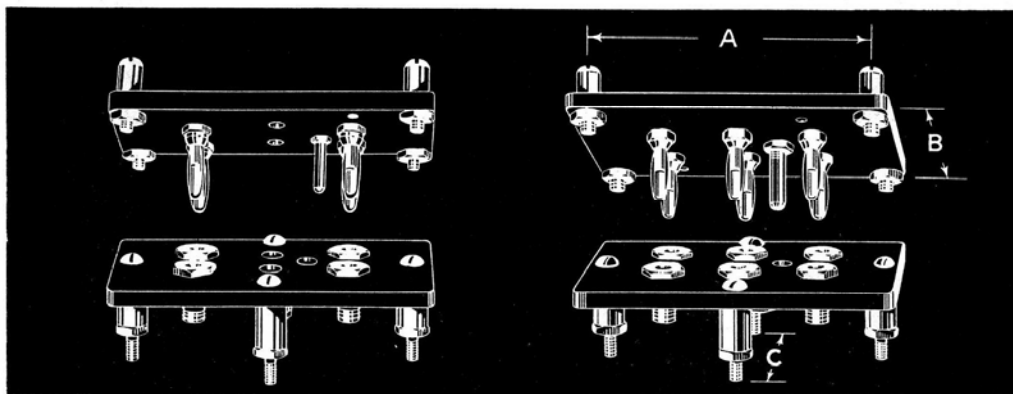

TYPE 274-EP
TYPE 274-EJ

TYPE 274-HP
TYPE 274-HJ

Type	Description	Dimensions			Code Word	Price
		A	B	C		
274-AP 274-AJ	2-Gang Plug 2-Gang Jack	1 ¹⁵ / ₁₆ "	1/4"	3/16"	STANPARBIB STANPARHUM	\$0.50 .50
274-BP 274-BJ	3-Gang Plug 3-Gang Jack	2 1/2"	3/4"	3/16"	STANPARSUN STANPARSIN	.60 .60
274-CP 274-CJ	4-Gang Plug 4-Gang Jack	1 ¹⁵ / ₁₆ "	1 1/4"	3/16"	STANPARSUM STANPARGIN	.60 .60
274-EP 274-EJ	4-Gang Plug 4-Gang Jack	See TYPES 274-HP and -HJ			STANPARGAS STANPARFAD	.75 .75
274-HP 274-HJ	6-Gang Plug 6-Gang Jack	2 3/4"	1 7/8"	1 7/8"	STANPARBED STANPARNOT	.90 .90
274-Q	Locating Pin (To insure correct orientation)	—	—	—	STANPARCAD	.05

PARTS AND ACCESSORIES

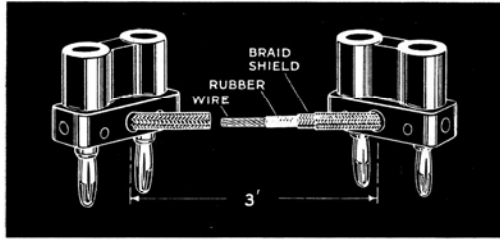

Type 274-NC Shielded Conductor

A concentric-shielded conductor with plugs.
 Capacitance: 100 μf per foot
 Impedance: About 30 ohms
 Code Word: STANPARZOO Price: \$1.50

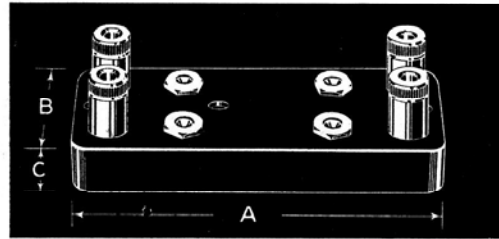

Type 274-RJ Four-Gang Jack Base

For mounting thermocouples, oxide rectifiers, etc.
 A = 3 $\frac{3}{4}$ inches C = $\frac{9}{16}$ inch
 B = 1 $\frac{1}{2}$ inches
 Code Word: STANPARPUP Price: \$1.00

Type 738-M Bracket

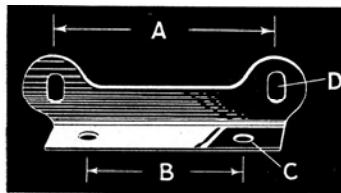

Mounting foot for TYPE 334 Condensers.
 A = 2 $\frac{1}{4}$ inch
 B = 1 $\frac{1}{2}$ inch
 C = For #8 machine screw
 D = For a #10 machine screw

Code Word: DOUBT

Price: \$0.12

Type 738-D Panel Screw

A nickel-plated brass machine screw for fastening panels to a relay rack.

A = $\frac{7}{16}$ inch
 B = 1 $\frac{1}{32}$ inch
 C = 10-32
 D = $\frac{5}{8}$ inch

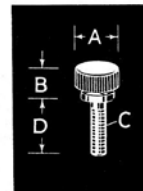

Code Word: UNIPARTBAT

Price: \$0.10

Type 274 Panel Terminal Insulators

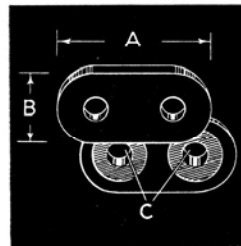

TWO
 TYPE
 138-
 VD

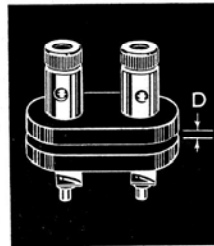

Bakelite insulators, used in pairs with TYPE 138-VD Binding Posts, for mounting on a metal panel.

A = 1 $\frac{1}{2}$ inches C = $\frac{3}{16}$ inch diam.
 B = $\frac{3}{4}$ inch D = $\frac{1}{8}$ inch to $\frac{5}{16}$ inch

Type	Bakelite Material	Code Word	Price (Pair)
274-Y	Black	STANPARBEL	\$0.20
274-Z	Yellow	STANPARHOD	.30

TYPE 379 RADIO-FREQUENCY CHOKE

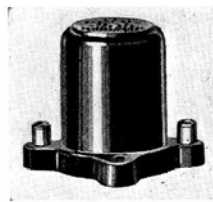

The TYPE 379 Radio-Frequency Chokes are available in two models, one of low inductance to carry a heavy current, and one of high inductance to carry a lower current. In both, the capacity does not exceed 4 micromicrofarads.

SPECIFICATIONS

Dimensions:
 2 x 1 $\frac{3}{4}$ x 1 $\frac{3}{4}$ inches.

Net Weight:
 2 $\frac{1}{2}$ ounces.

Mounting:
 See drawing.

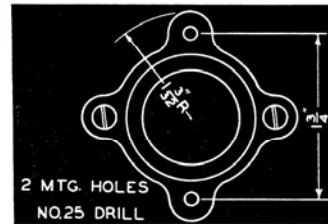

Type	In-ductance	Allowable Current		Frequency Range	D-C Resistance	Code Word	Price
		Intermit.	Continuous				
379-T	8 mh	300 ma	140 ma	1500-15,000 kc	35 Ω	JIMMY	\$1.25
379-R	60 mh	90 ma	65 ma	400- 2000 kc	140 Ω	JEWEL	1.25

INDEX TO BULLETIN 936

	<i>Page</i>		<i>Page</i>
Adjustable transformers	12, 13, 30, 31	Meter, direct-current	23
Air condensers, <i>see</i> <i>Condensers</i>		Meter, frequency	24, 25
Assembly, lead-in	44	Microphone hummer	24
Audio-frequency transformers	26-31	Monitor, amateur station	25
impedance-matching	30, 31	Mounting bases	36, 37, 47, 48
input	26, 27	Output transformers	28, 29
interstage	26, 27	Oxide rectifier	21
output	28, 29	Panel screw	48
Audio oscillator	24	Panel terminal insulators	48
Bases, plug and jack	36, 37, 47, 48	Plate, dial	42
Binding posts	43, 48	Plug bases	37, 47
Bracket	48	Plugs	46
Center-tap resistors	11	Porcelain insulators	44
Choke, radio-frequency	48	Potentiometers and rheostats	7-11
Compensated resistors	3	Precision dials	39
Condensers, decade	19	Rack, relay	32, 33
mica	20, 21	universal	33
variable air	14-18	Radio-frequency choke	48
Conductor, shielded	48	Rectifier, copper-oxide	21
Contacts, switch	43	Relay racks	32, 33
Controls, volume	4-6	Resistors, center-tap	11
Crystal holder	25	decade	2
Decade condenser	19	decade, compensated	3
resistance units	2, 3	fixed	1
Dial, friction-drive	39, 40, 42	slide-wire, compensated	3
lens	38, 39	variable	7-11
lock	38	Rheostat-potentiometers	7-11
plates	42	Shielded conductor	48
precision	39	Sockets, vacuum-tube	45
Direct-current meter	23	Stand-off insulators	44
Fixed condenser	20, 21	Stops, switch	43
resistor	1, 11	Switch contacts	43
Fluted knobs	41	knob	41
Frequency meter-monitor	25	stops	43
Friction-drive dial	39, 40, 42	Switches	42
Holder, crystal	25	Telephone transformer	30, 31
Hummer, microphone	24	Thermocouples, vacuum	22, 23
Impedance-matching transformers	30, 31	Transformers, audio-frequency	26-31
Inductor	37, 38	impedance matching	30, 31
form	36-38	input	26, 27
shield	36	interstage	26, 27
Input transformers	26, 27	output	28, 29
Insulators, lead-in	44	telephone	30, 31
panel terminal	48	variable-ratio	30, 31
porcelain	44	Unit-panel equipment	33-36
stand-off	44	Universal rack	33
Interstage transformers	26, 27	Vacuum thermocouples	22, 23
Jack bases	36, 37, 47, 48	Vacuum-tube sockets	45
Jack-top insulator	44	Variable air condensers	14-18
Jacks	46	Variable-ratio transformers	30, 31
Knobs	41	Variac	12, 13
Lead-in assembly	44	Variometer	38
Lens, dial	38, 39	Volume controls	4-6
Lock, dial	38	Wavemeter	24, 25

For Ordering Information, Discounts, etc., See Inside of Front Cover

Printed by The Barta Press
Cambridge, Mass., U. S. A.



GENERAL RADIO CO. Cambridge, Mass., U. S. A.

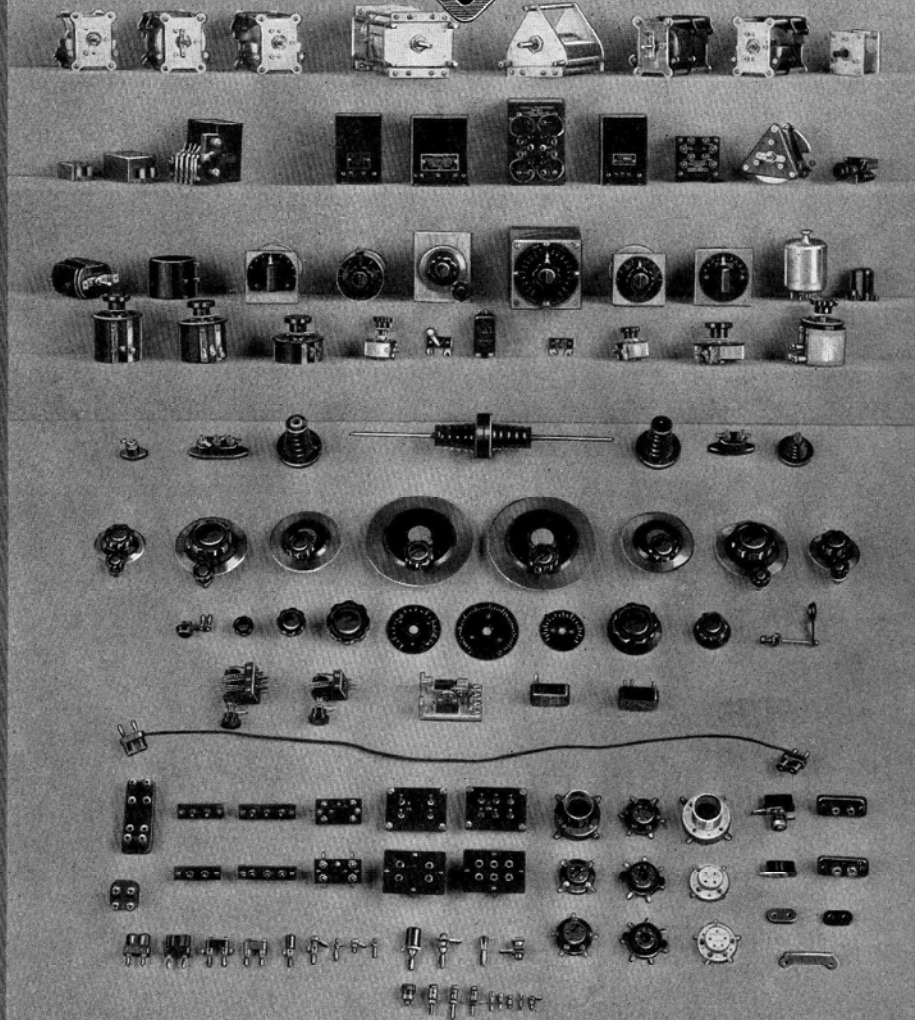

Bulletin
936

January
1935